

RW - THERMAL OVERLOAD RELAYS

High technology and safety
in electric motor protection

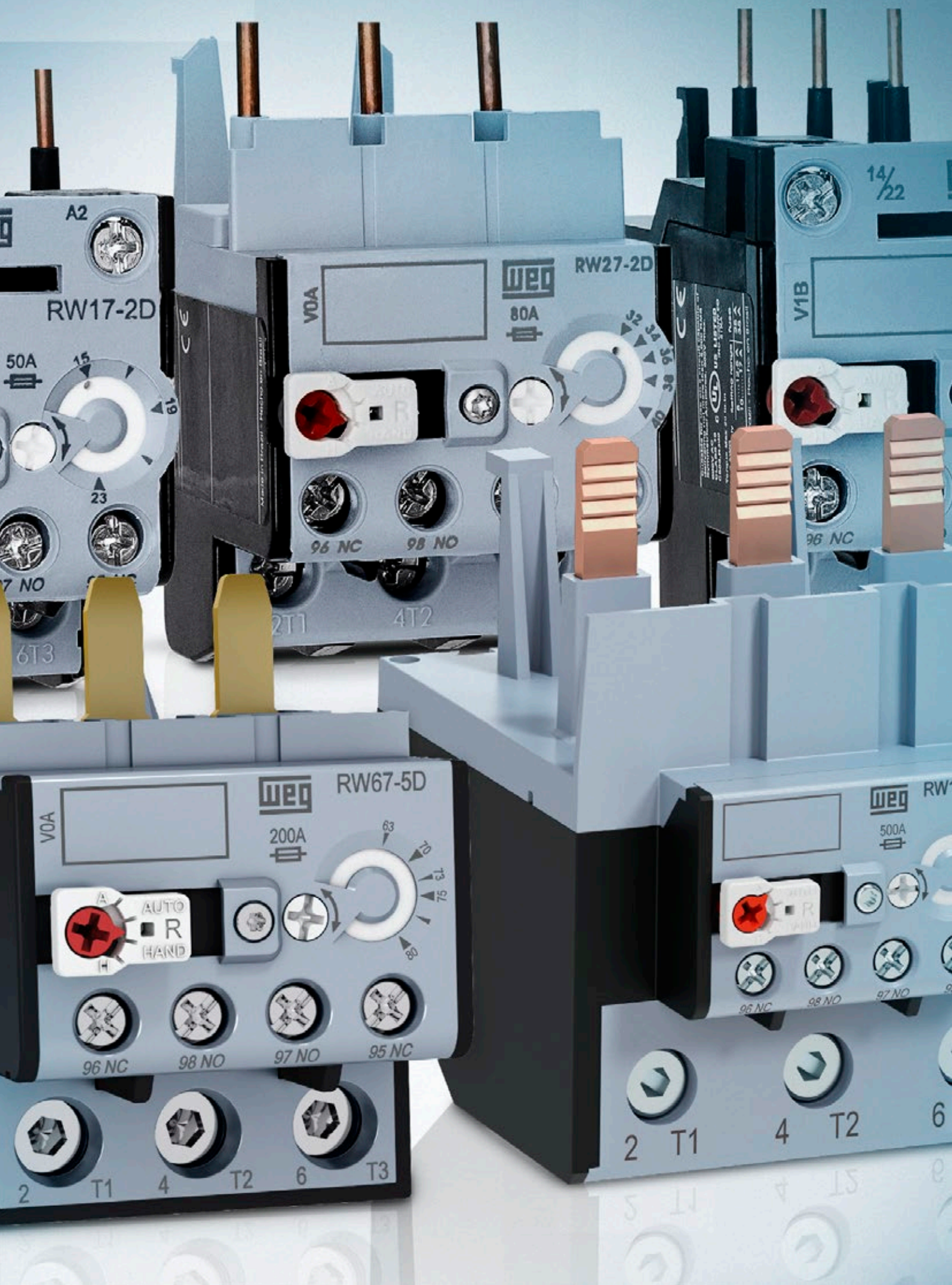

Motors | Automation | Energy | Transmission & Distribution | Coatings



RW - Thermal Overload Relays

Summary

RW Thermal Overload Relays	04
RW Thermal Overload Relays from 0.28 to 140 A	07
RW Thermal Overload Relays from 0.28 to 840 A	08
Accessories	09
Technical Data	11
Dimensions	14

RW Thermal Overload Relays

General Information

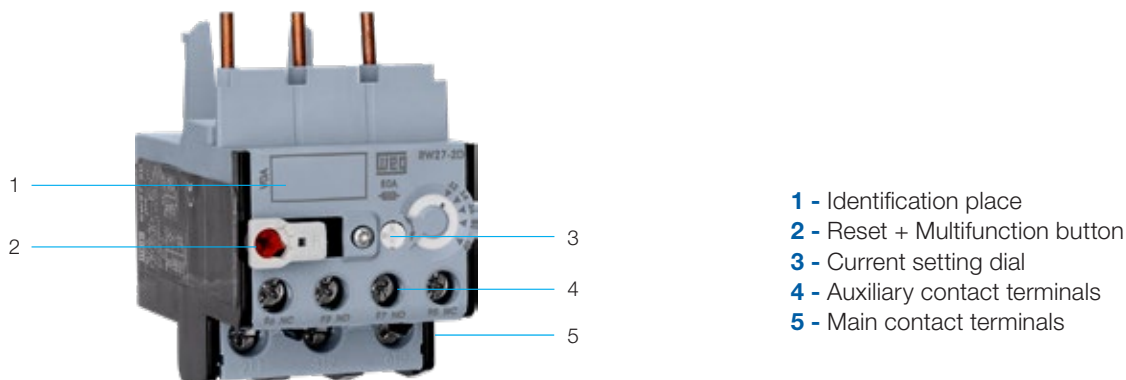

- 1 - Identification place
- 2 - Reset + Multifunction button
- 3 - Current setting dial
- 4 - Auxiliary contact terminals
- 5 - Main contact terminals

Description

The RW overload relays protect loads against overheating caused by overloads or phase failure. When we have an overload or a phase failure in the circuit, the motor current increases. Such current rise activates the tripping mechanism that will actuate on the auxiliary contacts 95-96 (NC) and 97-98 (NO).

The auxiliary contacts disconnect the load by means of a contactor. The time for disconnection is related to the overload current and the current set on the relay, which is properly represented on the relay tripping curve.

After the trip, it is necessary to wait for the system to reestablish in order to do the reset, which can be done automatic or manually.

Applications

The RW overload relays were designed to protect three-phase and single-phase AC motors, and DC motors¹⁾. If the RW overload relays are used in the protection of single-phase AC loads or DC loads, the wiring diagrams presented in this catalog must be observed.

Note: 1) RW317 and RW407 models must only be used with AC electric motors.

Overload Relays in Star-Delta Starters

When overload relays are used in star-delta starters, it should be noted that a current corresponding to $0.577 (\sqrt{3} / 3) \times I_n$ motor will pass through the contactor. The overload relay installed on the line contactor must then be set to $0.577 \times I_n$ motor.

Short-Circuit Protection

Fuses or circuit breakers must be used for short-circuit protection.

Weather Conditions

The RW overload relays are temperature compensated according to IEC 60947-4-1 and DIN VDE 0660 Part 102 standards in the temperature range between -20 °C and +60 °C. For temperatures between +60 °C and +80 °C, a correction factor should be used, according to the table below.

Ambient air temperature	Current correction factor
65 °C	0.94 x I _n
70 °C	0.87 x I _n
75 °C	0.81 x I _n
80 °C	0.73 x I _n

Altitude

Up to an altitude of 2,000 m, the relays do not undergo any changes in their specified performance. As the altitude increases, the atmospheric properties vary in terms of dielectric withstand, cooling capacity and pressure. The performance of the relay is therefore subject to a correction factor for proper operation at altitudes above 2,000 m.

Altitude (m)	Current correction factor I _v (A)	Voltage U _v (V)
2,000	1 x I _n	690
3,000	0.96 x I _n	550
4,000	0.93 x I _n	480
5,000	0.9 x I _n	420

RW Thermal Overload Relays

Phase Failure Sensitivity

According to IEC 60947-4-1, when two poles of the relay have overloads of 15%, and one of the poles have zero current, the overload relay must trip/open in less than 2 hours.

For effective protection against phase failure, specific products must be considered for this function, providing actuation in a few seconds.

Characteristic Tripping Curve

The characteristic tripping curve is the ratio between time and tripping current in the form of multiples of the rated current for symmetrical three-phase loads operating from the cold state.

The tripping current limits on the RW bimetallic overload relays for symmetrical three-phase loads are between 105% and 120% of the rated current. The characteristic tripping curve of an RW overload relay is valid when all the three phases are under the same current intensity.

In cases of phase failure, the tripping time tends to be longer or a higher current value will be needed to trip the mechanism. This required higher current value may result in damage to the load if it remains for a long time.

In order to prevent that, the RW overload protection relays have been developed with technology that makes them phase failure sensitive, accelerating the action of the two active phases on the tripping mechanism, thus maintaining the appropriate tripping curve characteristics.

The following graph shows the characteristic tripping curves with the average values of the tolerance range, considering an ambient temperature of 20 °C starting from the cold state. These curves show the tripping time in relation to the rated current in operating conditions with three and two phases.

For a different operating temperature, the thermal relay tripping time is reduced to approximately 25% of that.

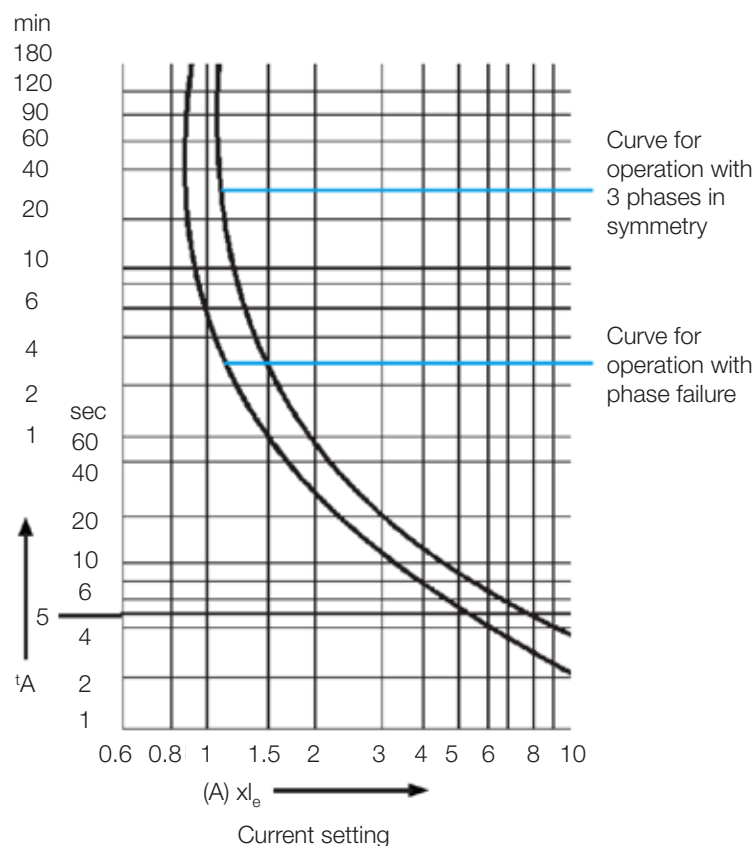

RW Thermal Overload Relays

Multifunction Reset / Test Button

The relay has a Reset button and on the same button four functions, as follows:

A - Automatic reset function only. The stop/test function is not allowed;

AUTO - Automatic reset function and stop/test function;

HAND - Manual reset function and stop/test function;

H - Manual reset function only. The stop/test function is not allowed;



Operation description:

In the **H** (manual - reset only) and **A** (automatic - reset only) positions, the stop/test functions are blocked, while in the **HAND** (manual) and **AUTO** (automatic) positions, test simulation and tripping by directly pressing the Reset button are possible. In the **H** and **HAND** positions, after the relay trips (relay tripped), it has to be manually reset by pressing the Reset button, while in the **A**

and **AUTO** positions, the relay is automatically reset after tripping. The **H**, **HAND**, **AUTO** and **A** functions are set by turning the red button without pressing it, positioning it in the indications of the Reset button. In the change from **HAND** to **AUTO**, the Reset button must be lightly pressed simultaneously with the turning of the red button.

Functions	H	HAND	AUTO	A
Relay reset	Manual ¹⁾	Manual ¹⁾	Automatic	Automatic
Auxiliary contact 95-96 (NC) opening test	Function is disabled	Test/stop is allowed	Test/stop is allowed	Function is disabled
Auxiliary contact 97-98 (NO) opening test	Function is disabled	Test/stop is allowed	Test/stop is allowed	Function is disabled

Note: 1) Allow cooling for a short time before resetting the relay.

Recovery Time

The RW overload relays require a certain time for the bimetallic strips to cool down after the trip. Only after this time can the relay be reset.

This time is a function of the tripping curve and the intensity of the tripping current. After the relay trips due to overload, the load cools down during the relay reset time.

Operation with Frequency Inverter

The RW17, RW27, RW67 and RW117 overload relays can operate with frequency inverters.

Depending on the inverter frequency of operation, the current must be set above the motor rated current, due to eddy currents and skin effects.



RW Thermal Overload Relays 0.28...140 A

- Bimetallic overload relay with trip class 10
- Phase failure sensitivity
- Temperature compensation
- Manual or automatic reset
- Direct mounting to mini-contactors and contactors
- Allow individual mounting by means of an accessory¹⁾
- Adjustable multifunction button with the functions: HAND, AUTO, H or A
- Auxiliary contacts 1NO + 1NC

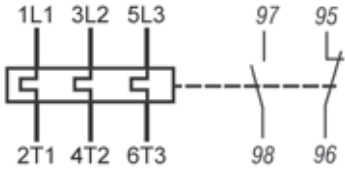
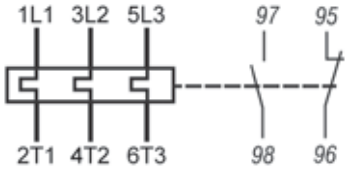

Direct mounting Screw terminal	Current range (A)	Diagram	Maximum fuse (gL/gG) ²⁾	Blue version		Weight kg
				Code	Part Number	
CW07 CWC07...16	0.28...0.4		2	RW17-1D3-D004	12450892	0.155
	0.4...0.63		2	RW17-1D3-C063	12450895	
	0.56...0.8		2	RW17-1D3-D008	12450896	
	0.8...1.2		4	RW17-1D3-D012	12450897	
	1.2...1.8		6	RW17-1D3-D018	12450898	
	1.8...2.8		6	RW17-1D3-D028	12450899	
	2.8...4		10	RW17-1D3-U004	12450900	
	4...6.3		16	RW17-1D3-D063	12450901	
	5.6...8		20	RW17-1D3-U008	12450903	
	7...10		25	RW17-1D3-U010	12450905	
	8...12.5		25	RW17-1D3-D125	12450906	
	10...15		35	RW17-1D3-U015	12450907	
	11...17		40	RW17-1D3-U017	12450908	
	CWC025		7...10	25	RW17-2D3-U010	
8...12.5		25	RW17-2D3-D125	12450910		
10...15		35	RW17-2D3-U015	12450911		
11...17		40	RW17-2D3-U017	12450912		
15...23		50	RW17-2D3-U023	12450913		
22...32		63	RW17-2D3-U032	12450914		
CWB9...38		0.28...0.4		2	RW27-2D3-D004	12140441
	0.43...0.63	2		RW27-2D3-C063	12140442	
	0.56...0.8	2		RW27-2D3-D008	12140443	
	0.8...1.2	4		RW27-2D3-D012	12140444	
	1.2...1.8	6		RW27-2D3-D018	12140445	
	1.8...2.8	6		RW27-2D3-D028	12140446	
	2.8...4	10		RW27-2D3-U004	12140447	
	4...6.3	16		RW27-2D3-D063	12140448	
	5.6...8	20		RW27-2D3-U008	12140449	
	7...10	25		RW27-2D3-U010	12140450	
	8...12.5	25		RW27-2D3-D125	12140451	
	10...15	35		RW27-2D3-U015	12140452	
	11...17	40		RW27-2D3-U017	12140453	
	15...23	50		RW27-2D3-U023	12140454	
	22...32	63		RW27-2D3-U032	12140455	
	32...40	90		RW27-2D3-U040	12140456	
	CWB40...80	25...40		80	RW67-5D3-U040	13368960
32...50		80	RW67-5D3-U050	13368961		
40...57		100	RW67-5D3-U057	13368962		
50...63		100	RW67-5D3-U063	13368963		
57...70		125	RW67-5D3-U070	13368964		
63...80		125	RW67-5D3-U080	13368965		
CWB95...125		63...80	200	RW117-3D3-U080	14204758	0.480
	75...97	225	RW117-3D3-U097	14204759		
	90...112	250	RW117-3D3-U112	14204761		
	110...140	315	RW117-3D3-U140	14204762		

Notes: 1) Except for RW17-1D and RW17-2D.

2) Maximum fuse for Type 2 coordination (gL/gG).

RW Thermal Overload Relays 0.28...840 A

- Bimetallic overload relay with trip class 10
- Phase failure sensitivity
- Temperature compensation
- Manual or automatic reset
- Direct mounting to contactors
- Allow individual mounting by means of an accessory
- Adjustable multifunction button with the functions: HAND, AUTO, H or A
- Auxiliary contacts 1NO + 1NC



Direct mounting	Current range (A)	Diagram	Maximum fuse (gL/gG) ¹⁾	Code	Part Number	Weight kg
CWM9...40	0.28...0.4		2	RW27-1D3-D004	10045630	0.165
	0.43...0.63		2	RW27-1D3-C063	10186032	
	0.56...0.8		2	RW27-1D3-D008	10186033	
	0.8...1.2		4	RW27-1D3-D012	10045631	
	1.2...1.8		6	RW27-1D3-D018	10045632	
	1.8...2.8		6	RW27-1D3-D028	10452548	
	2.8...4		10	RW27-1D3-U004	10452213	
	4...6.3		16	RW27-1D3-D063	10045633	
	5.6...8		20	RW27-1D3-U008	10452197	
	7...10		25	RW27-1D3-U010	10045634	
	8...12.5		25	RW27-1D3-D125	10452967	
	10...15		35	RW27-1D3-U015	10452384	
	11...17		40	RW27-1D3-U017	10452204	
	15...23		50	RW27-1D3-U023	10452205	
22...32	63	RW27-1D3-U032	10452382			
CWM32/40	25...40		80	RW67-1D3-U040	10452216	0.320
	32...50		100	RW67-1D3-U050	10452217	
CWM50...80	25...40		80	RW67-2D3-U040	10844133	0.320
	32...50		100	RW67-2D3-U050	10186035	
	40...57		100	RW67-2D3-U057	10452201	
	50...63		100	RW67-2D3-U063	10452218	
	57...70		125	RW67-2D3-U070	10045635	
	63...80		125	RW67-2D3-U080	10045636	
CWM95/105	63...80		200	RW117-1D3-U080	10186370	0.490
	75...97		225	RW117-1D3-U097	10410002	
	90...112		250	RW117-1D3-U112	10410003	

Note: 1) Maximum fuse for Type 2 coordination (gL/gG).



Separate mounting or with claws	Current range (A)	Diagram	Maximum fuse (gL/gG) ¹⁾	Code	Part Number	Weight kg
CWM112	63...80		200	RW117-2D3-U080	11033689	0.750
	75...97		225	RW117-2D3-U097	10045646	
	90...112		250	RW117-2D3-U112	10410004	
CWM112...300. CWM400. CWM450, CWM560	100...150		315	RW317-1D3-U150	10045647	1.985
	140...215		355	RW317-1D3-U215	10410005	
	200...310		500	RW317-1D3-U310	10410006	
	275...420		710	RW317-1D3-U420	10410007	
CWM450. CWM560. CWM500...800	400...600		1,000	RW407-1D3-U600	10452250	3.435
	560...840		1,250	RW407-1D3-U840	10045637	

Accessories

Individual Mounting Base

Illustrative picture	Description	Use with relays	Code	Part Number	Weight kg
	It allows overload relays to be mounted directly via screws or on DIN rail 35 mm	RW27-1D	BF27D	10410085	0.050
		RW27-2D	BF27-2D	13598034	
		RW67-1D	BF67-1D	10410086	0.095
		RW67-2D	BF67-2D	10046505	
		RW67-5D	BF67-5D	13369075	
		RW117-1D	BF117D	10045719	0.21
		RW117-3D	BF117-3D	14197548	

Mounting Clamps for Direct Mounting of Overload Relay on Contactor

Illustrative picture	Use with contactors	Use with relays	Construction type	Code	Part Number	Weight kg
	CWM32/40	RW67-1D	Busbars	GA67-1D	10186061	0.03
	CWM50...80	RW67-2D		GA67-2D	10186062	0.03
	CWB40...80	RW67-5D ¹⁾		GA67-B80	13557165	0.03
	CWM112	RW117-2D	Cables	GA117D	10185899	0.13
	CWM112/150	RW317	Busbars	GA317-1D	10185904	0.25
	CWM180/215			GA317-2D	10185900	0.28
	CWM250/300			GA317-3D	10185901	0.47
	CWM400			GA317-10D	10187159	0.48
	CWM450/560			GA317-11D	14313668	0.25
	CWM450/560			RW407	GA407-1D	14313709

Note: 1) The mounting clamps GA67-B80 are applicable to all RW67 overload relays, making them compatible with CWB40...80 contactors.

External Reset Cable

Illustrative picture	Description	Cable length	Code	Part Number	Weight kg
	Flexible metal cable for external reset (no need to open the electrical panel), compatible with all RW thermal overload relays. Notes: - Hole for external mounting: Ø6.5...7 mm - Panel plate thickness: 2...4.25 mm	250 mm	ERC250RW	11795102	0.034
		375 mm	ERC375RW	11795097	0.036
		500 mm	ERC500RW	11795105	0.041

Phase Insulator

Illustrative picture	Description	Use with relay	Code	Part Number	Weight kg
	Plastic insulator and fixing screws for use where the external connections of the power terminals exceed the side dimension of the connection busbar. It can be applied to both the top and bottom of the relay.	RW317	IBRW317	11558425	0.044

Button with Shaft for External Reset

Illustrative picture	Description	Use with relay	Code	Part Number	Weight kg
	Blue RESET flush button with shaft. Adjustable length: 250 to 22.5 mm	RW	CSW-BHF437	12471376	0.032
	Blue RESET extended button with shaft. Adjustable length: 250 to 22.5 mm		CSW-BHS437	12471409	0.032

Accessories

Power Terminal Cover Protection

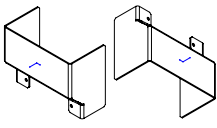
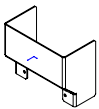
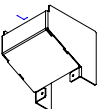
Illustrative picture	Description	Number of pieces	Use with	Code	Part Number	Weight kg
	Flameproof polycarbonate cover protections the power terminals of the overload relay, providing the frontal part of the overload relay with IP20 protection rating	2	RW317	BMPRW317	13072101	0.18
		1	RW317	BMP1RW317	13072316	0.09
	Flameproof polycarbonate cover protections the power connection between the contactor and overload relay, providing the frontal part with IP20 protection rating	1	CWM400 + RW317 + GA317-10D	BMP1RW317-CWM400	13072317	0.17
		1	CWM450/560 + RW317 + GA317-11D	BMP1RW317-CWM560	14286865	0.17



Technical Data

Basic Data

Models	RW17	RW27	RW67	RW117	RW317	RW407
Compliance with the standards	IEC 60947-1 and UL 508					
Frequency limits (Hz)	25...400				50/60	
Use in direct current	Yes				No	
Maximum frequency of operation cycles (operations/h)	15					
Protection rating (IEC 60529)	Main terminals	IP10			IP00	
	Auxiliary contacts	IP10				
	Other regions	IP20			IP20	
Mounting	Direct to mini-contactors	Directly to contactors or with screws and DIN rail 35 mm (EN 50022) using an accessory			Directly to contactors by means of accessories or with screws	
Resistance to mechanical shocks (IEC 60068-2-27 - 1/2 sine wave) (g/ms)	10/11					
Ambient temperature	Transport and storage	-50 °C...+80 °C				
	Operation	-20 °C...+70 °C				
	Temperature compensation	-20 °C...+60 °C				
Maximum operation altitude without modification in the rated values	2,000 m					

Main Contacts

Models	RW17	RW27	RW67	RW117	RW317	RW407
Rated insulation voltage U_i (IEC 60947-4-1) (V)	690				1,000	
(pollution degree 3) UL, CSA (V)	600					
Rated impulse withstand voltage U_{imp} (IEC 60947-1) (kV)	6				8	
Current settings/maximum fuse (gL / gG) (A)	0.28...0.4 / 2	0.28...0.4 / 2	25...40 / 80	63...80 / 200	100...150 / 315	320...480 / 800
	0.43...0.63 / 2	0.43...0.63 / 2	32...50 / 100	75...97 / 225	140...215 / 355	400...600 / 1.000
	0.56...0.8 / 2	0.56...0.8 / 2	40...57 / 100	90...112 / 250	200...310 / 500	560...840 / 1.250
	0.8...1.2 / 4	0.8...1.2 / 4	50...63 / 100	110...140 / 315	275...420 / 710	
	1.2...1.8 / 6	1.2...1.8 / 6	57...70 / 125			
	1.8...2.8 / 6	1.8...2.8 / 6	63...80 / 125			
	2.8...4 / 10	2.8...4 / 10				
	4...6.3 / 16	4...6.3 / 16				
	5.6...8 / 20	5.6...8 / 20				
	7...10 / 25	7...10 / 25				
	8...12.5 / 25	8...12.5 / 25				
	10...15 / 35	10...15 / 35				
	11...17 / 40	11...17 / 40				
	15...23 / 50	15...23 / 50				
	22...32 / 63	22...32 / 63				
	32...40 / 90					
Average power dissipation per pole (W)	≤3	≤3	≤5.5	≤5.5	≤15	≤20

Technical Data

Auxiliary Circuit

Models			RW17	RW27	RW67	RW117	RW317	RW407
Compliance with the standards			IEC 60 947-4-1 and UL 508					
Rated insulation voltage U_i (pollution degree 3)	IEC	(V)	690					
	UL, CSA	(V)	600					
Rated operational voltage U_e	IEC	(V)	690					
	UL, CSA	(V)	600					
Conventional thermal current I_m ($\theta \leq 55$ °C)			6					
Rated operational current I_e								
AC-14/AC-15 (IEC 60947-5-1)	24 V	(A)	4					
	60 V	(A)	3.5					
	125 V	(A)	3					
	230 V	(A)	2					
	400 V	(A)	1.5					
	500 V	(A)	0.5					
UL, CSA	690 V	(A)	0.3					
			C600					
	24 V	(A)	1					
	60 V	(A)	0.5					
	110 V	(A)	0.25					
	220 V	(A)	0.1					
UL, CSA			R300					
Short circuit protection with fuse (gL/gG)			(A) 6					
Minimum voltage/permissible current (IEC 60947-5-4)			17V / 5 mA					

Terminal Capacity and Tightening Torque - Power Circuit

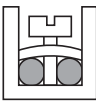
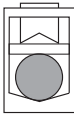
Models			RW17 and RW27	BF27D	RW67-1D and BF67-1D	RW67-2D, RW67-5D, BF67-2D and BF67-5D	RW117 and BF117D
Mounting system screw type			M4 x 10 Slot / Phillips	M4 x 10 Slot / Phillips	M6 x 16.8 Slot / Phillips	M6 x 16.8 Allen	M10 Allen
Conductor cross-section							
Flexible conductor	(mm ²)		-	1.5...10	-	-	-
Conductor with terminal/solid wire	(mm ²)		-	1.5...6.0	-	-	-
Wire / cable AWG			-	14...6	-	-	-
Torque	(Nm)		-	2.3	-	-	-
Flexible conductor	(mm ²)		1.5...10	-	-	-	-
Conductor with terminal/solid wire	(mm ²)		1.5...6.0	-	-	-	-
Wire / cable AWG			14...6	-	-	-	-
Torque	(Nm)		2.3	-	-	-	-
Conductor connection at the bottom							
Flexible conductor	(mm ²)		-	-	6.0...35	6.0...35	25...35
Conductor with terminal/solid wire	(mm ²)		-	-	6.0...35	6.0...35	25...35
Flexible conductor	(mm ²)		-	-	6.0...35	6.0...35	25...35
Wire / cable AWG			-	-	18...2	18...2	8...1/0
Torque	(Nm)		-	-	4	4	6
Models			RW317 (100 A a 215 A)		RW317 (200 A a 420 A)		RW407
Mounting system screw type			M8 Hexagonal		M10 Hexagonal		M12 Hexagonal
Cable with terminal (mm ²)			35...120		95...150		-
Busbars (mm) - maximum size			2 x (25x5)		2 x (25x5)		2 x (60x10)
Torque (Nm)			16		26		26

Terminal Capacity and Tightening Torque - Auxiliary Contacts

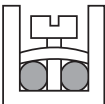
Models			RW17...407
Mounting system screw type			M3.5 x 10 Fenda / Philips
Conductor cross-section			
Wire / conductor with or without terminal	(mm ²)		2 x 1...2.5
Torque	(Nm)		1.5

Technical Data

Wiring Diagrams

Direct Current Motor Protection

One-pole

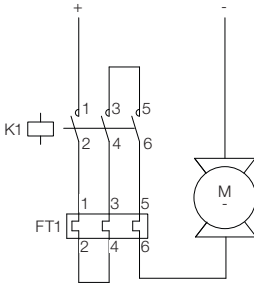

Two-pole

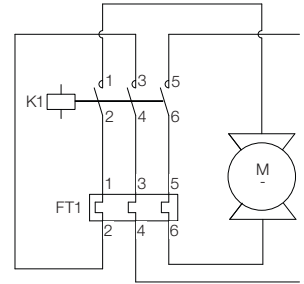

Alternating Current Motor Protection

Three-pole

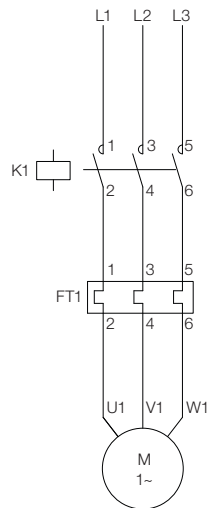

Two-pole

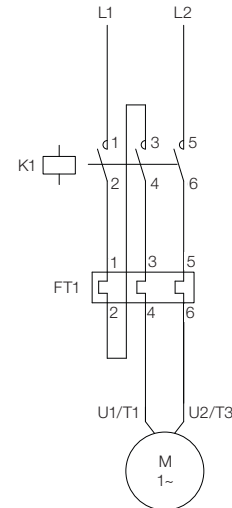

Suggestion for Connecting the Control Circuit of the Overload Relay + Contactor

Direct On-Line Starter (1 Direction of Rotation)

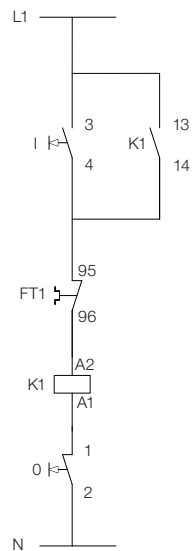

Direct On-Line Starter (2 Directions of Rotation)

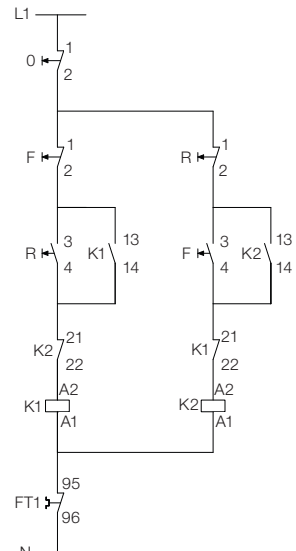

Dimensions (mm)

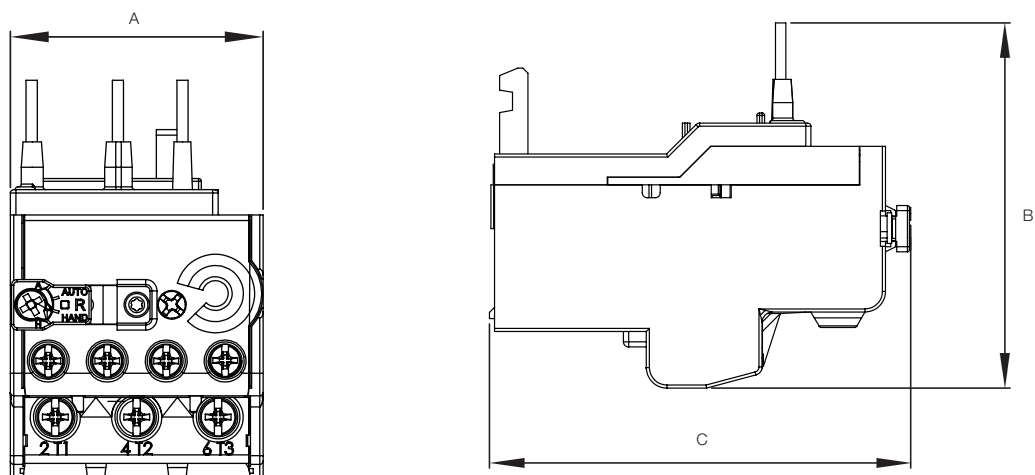

	RW17-1D RW17-2D RW27-1D RW27-2D	RW67-1D	RW67-2D	RW67-5D	RW117-1D RW117-3D
A	45.0	50.0	50.0	50.0	75.0
B	71.5	76.5	81.5	71.5	99.5
C	83.5	106.5	106.5	106.5	98.8

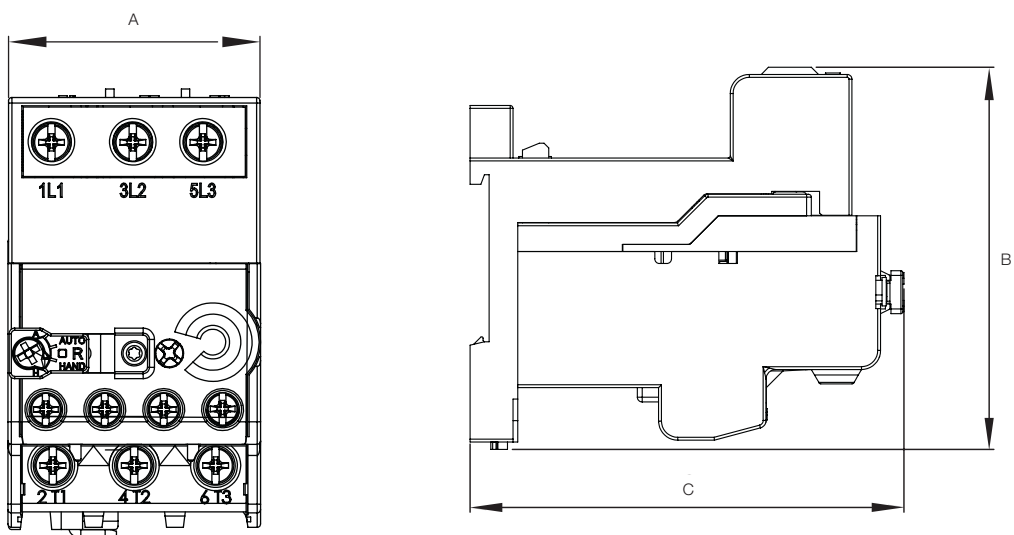

	BF27D + RW27-1D BF27-2D + RW27-2D	BF67-1D + RW67-1D BF67-2D + RW67-2D BF67-5D + RW67-5D	BF117D + RW117-1D RW117-2D BF117-3D + RW117-3D
A	45.0	50.0	75.0
B	80.0	71.0	116.4
C	92.5	106.0	107.0

Dimensions (mm)

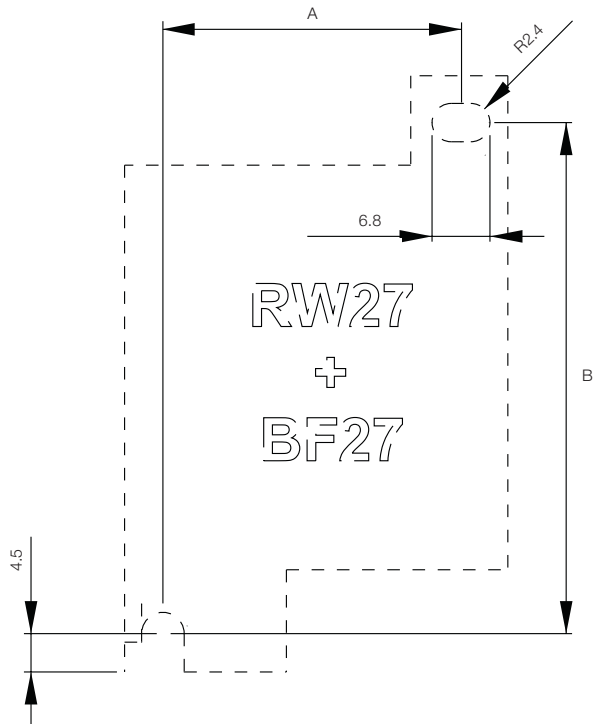

	BF27D	BF27-2D
A	34	34
B	60	65

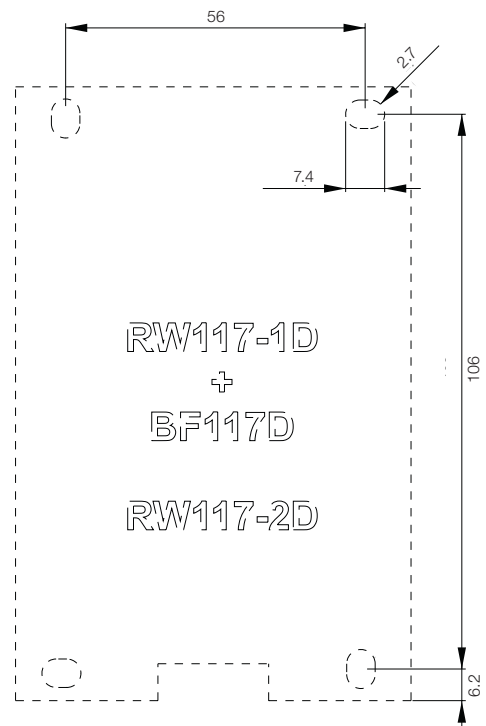
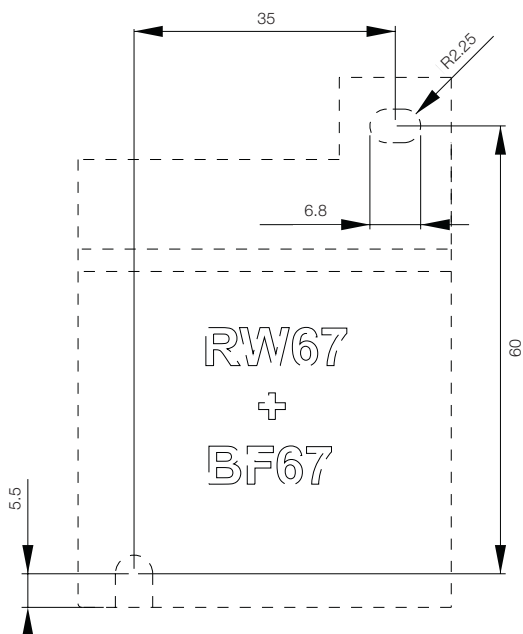

Dimensions (mm)

RW317

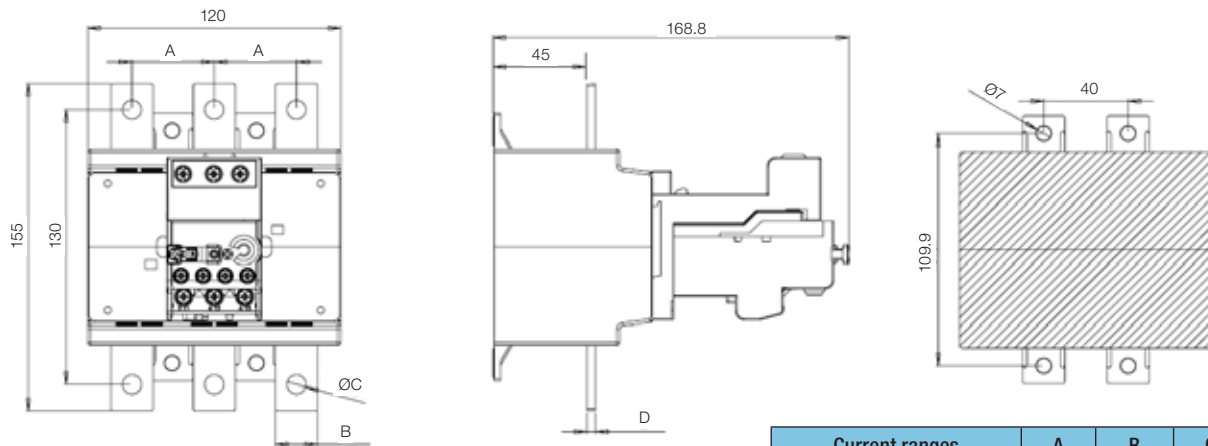

Current ranges	A	B	C	D
100...150 A	39	20	9	4
140...215 A				
200...310 A	45	25	11	5
275...420 A				

RW407

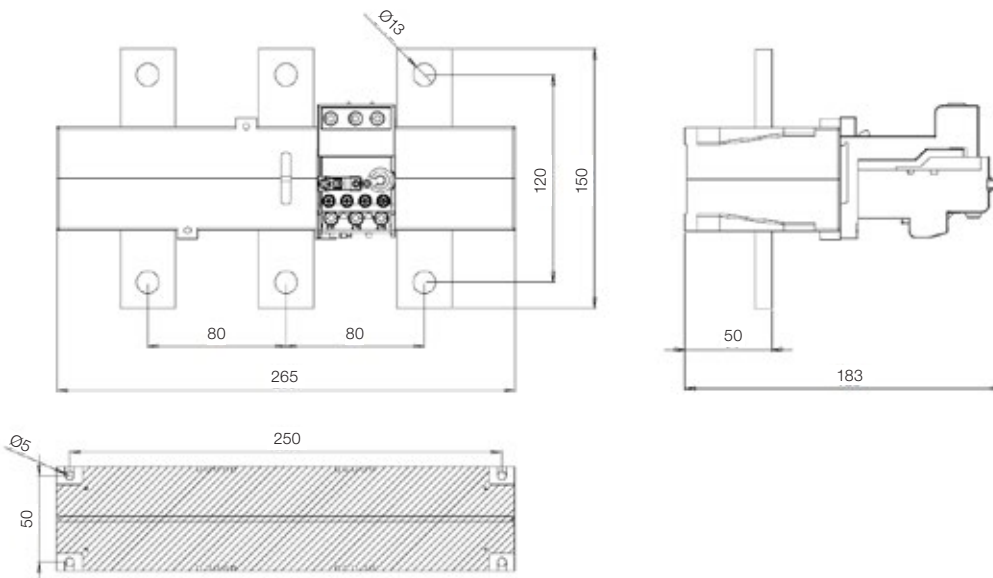

Mounting Position

RW17...407

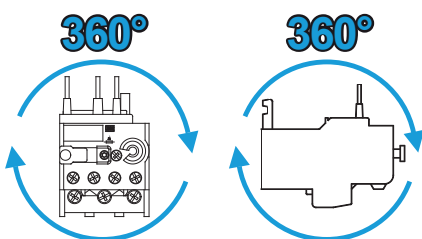

Dimensions (mm)

ERCRW

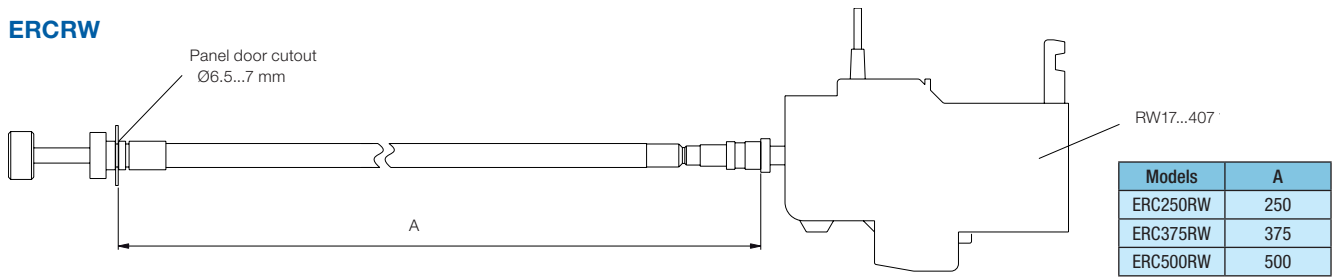

IBRW317

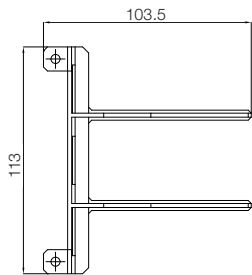

RW317+IBRW317

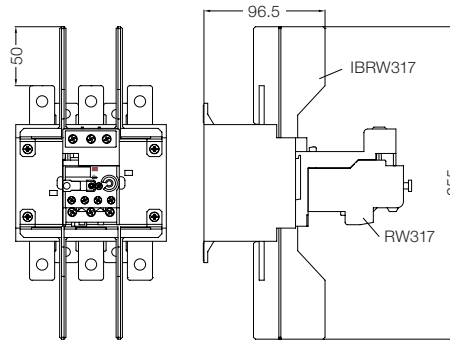

BMPRW317

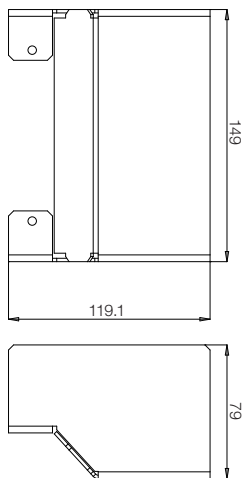

RW317+ BMPRW317

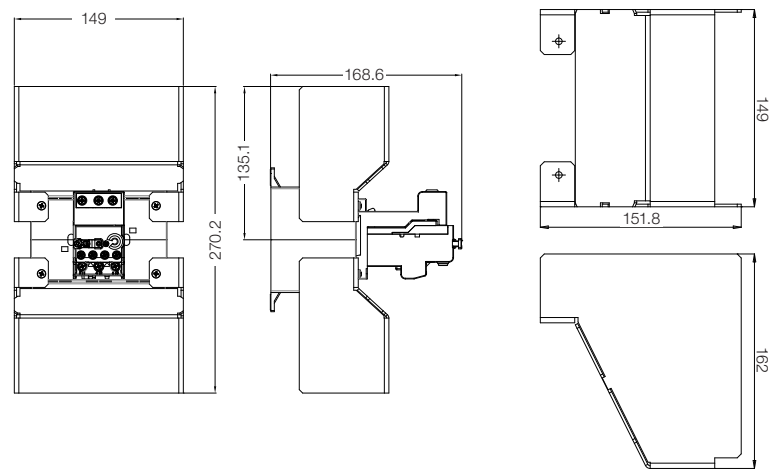

BMP1RW317-CWM400

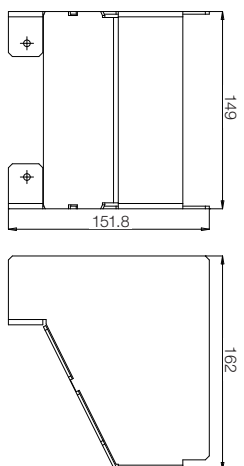

BMP1RW317-CWM560

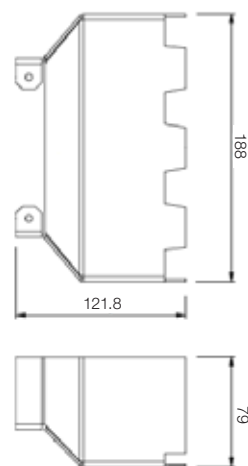

Dimensions (mm)

CW07 + RW17-1D + A17 Adapter

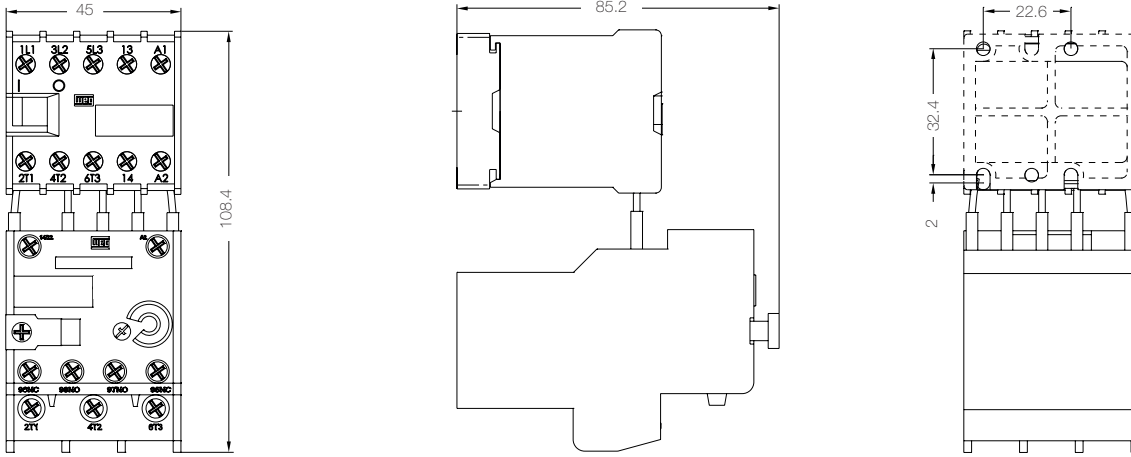

CWC07...16 + RW17-1D

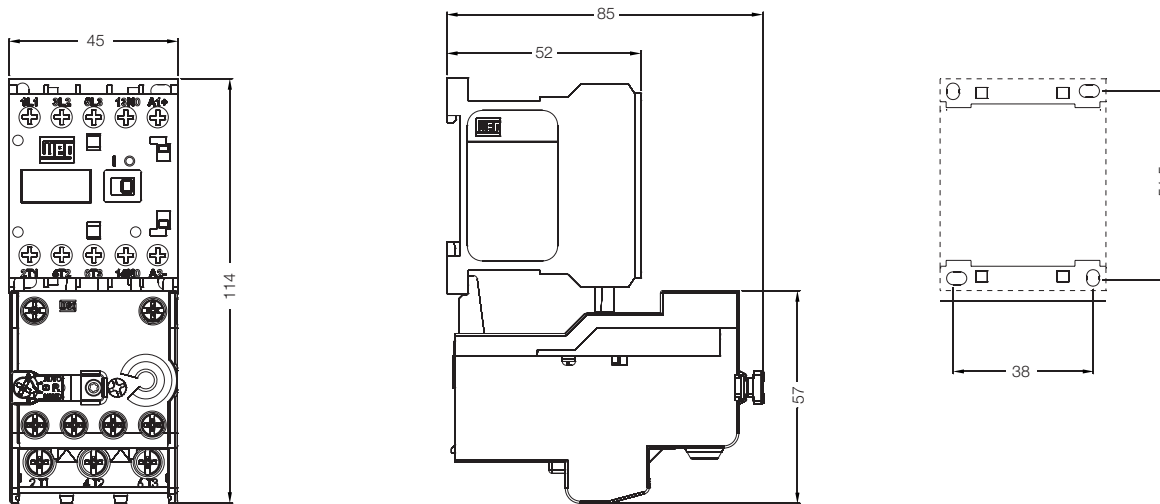

CWC025 + RW17-2D

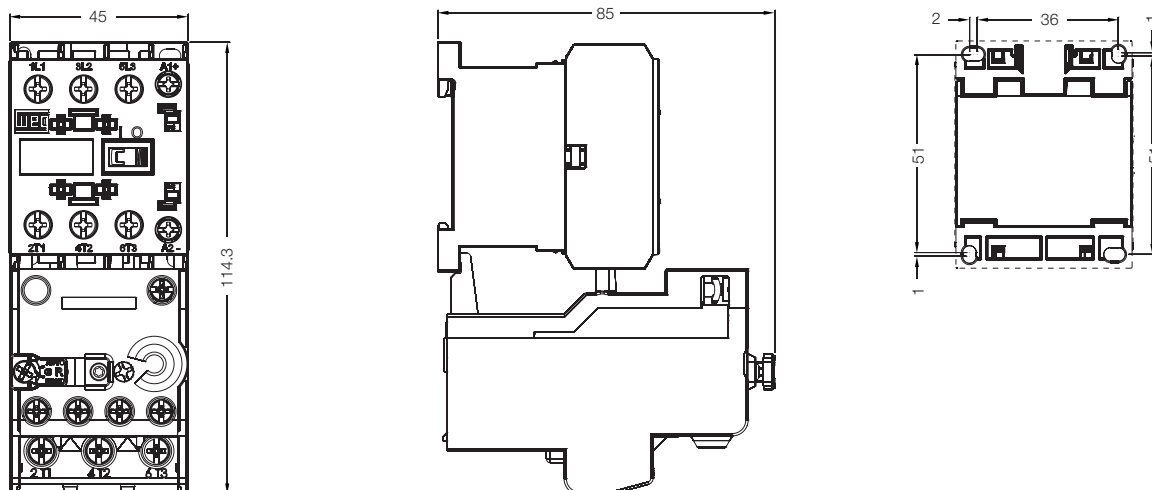

Dimensions (mm)

CWB9...38 + RW27-2D

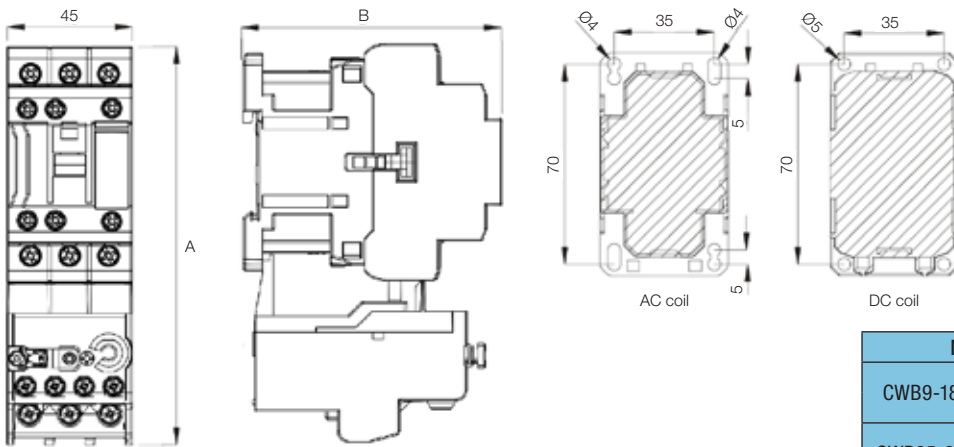

Models		A	B
CWB9-18	AC coil	136.4	89.5
	DC coil	136.4	98.5
CWB25-38	AC coil	143	93
	DC coil	143	102.2

CWB40...80 + RW67-5D

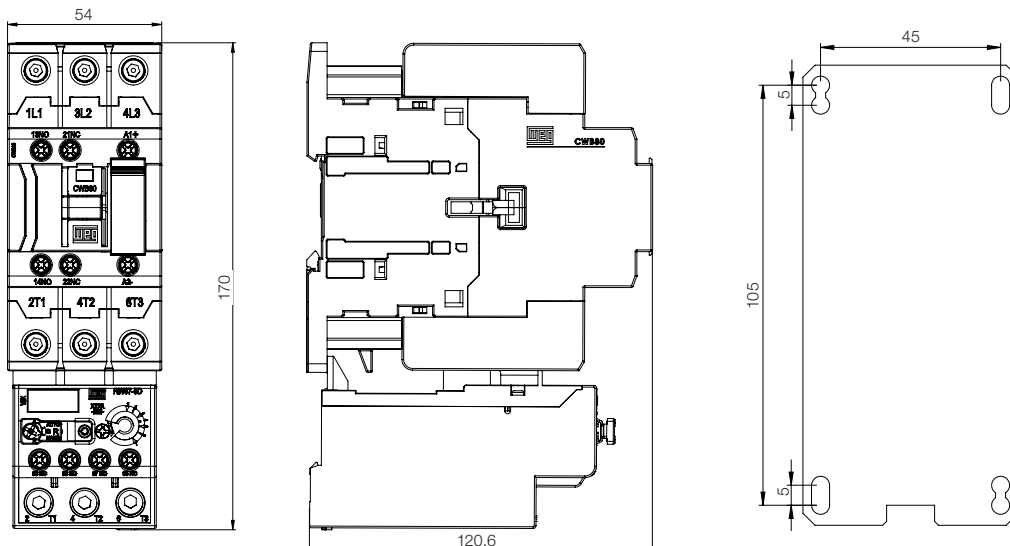

CWB95...125 + RW117-3D

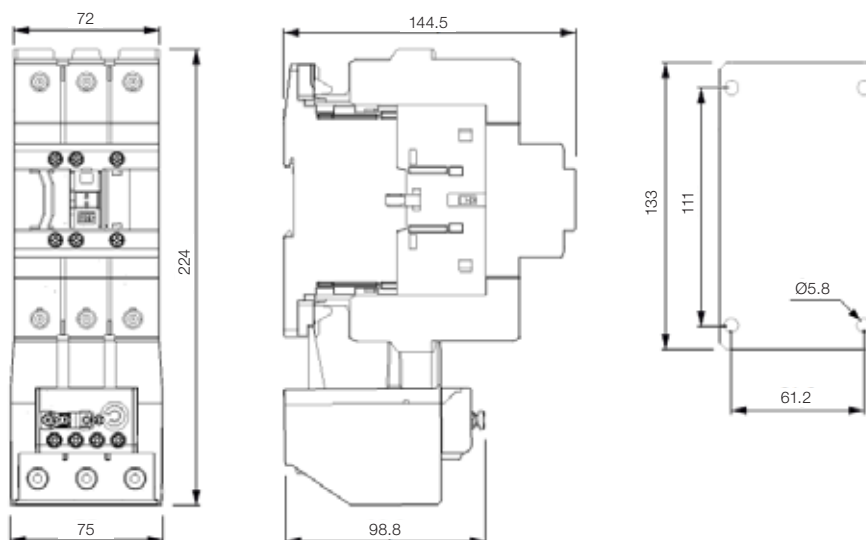

Dimensions (mm)

CWM9...25 + RW27-1D

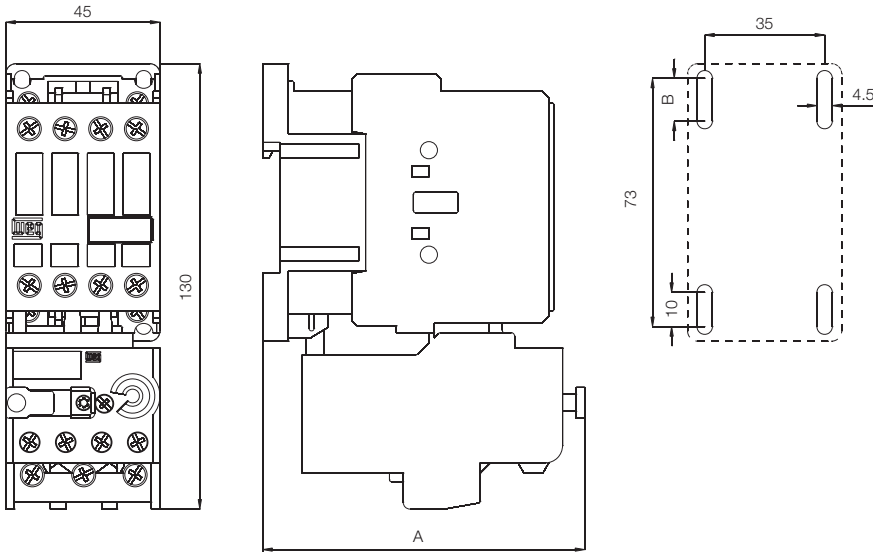

CWM9...25	A	B
AC coil	94	4.8
DC coil	124	13

CWM32 + RW27-1D

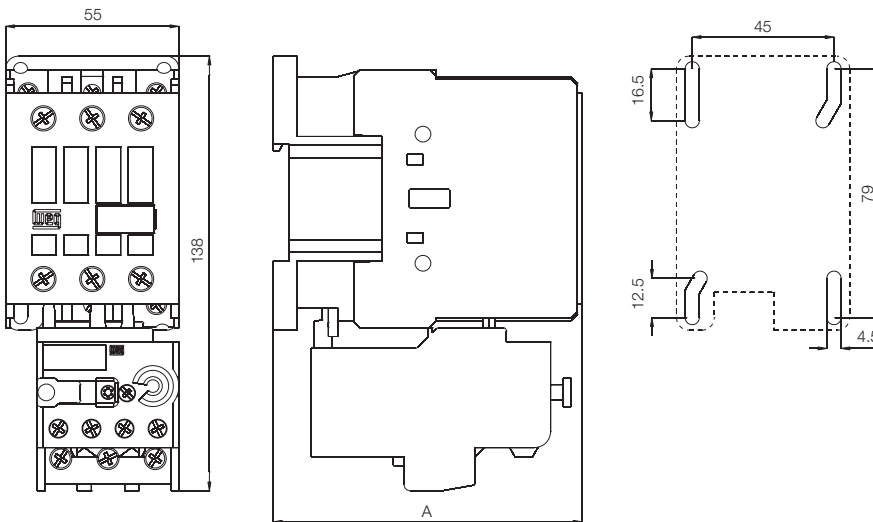

CWM32	A
AC coil	98
DC coil	118

CWM32/40 + RW67-1D

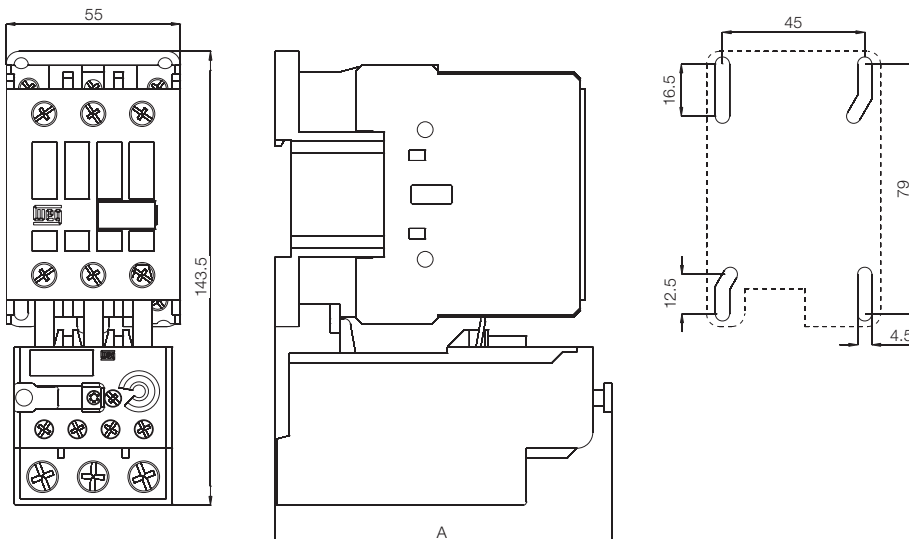

CWM32/40	A
AC coil	106.5
DC coil	126.5

Dimensions (mm)

CWM50...80 + RW67-2D

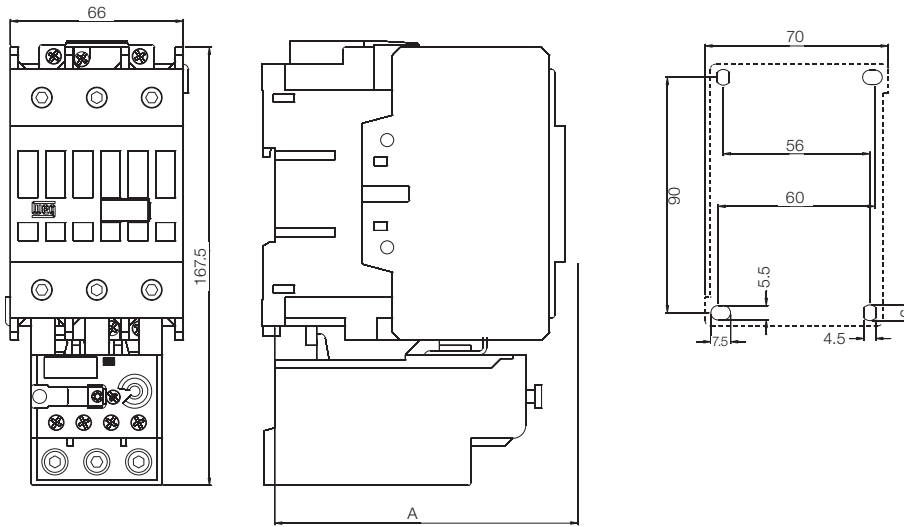

CWM50...80	A
AC coil	116
DC coil	116

CWM95/105 + RW117-1D

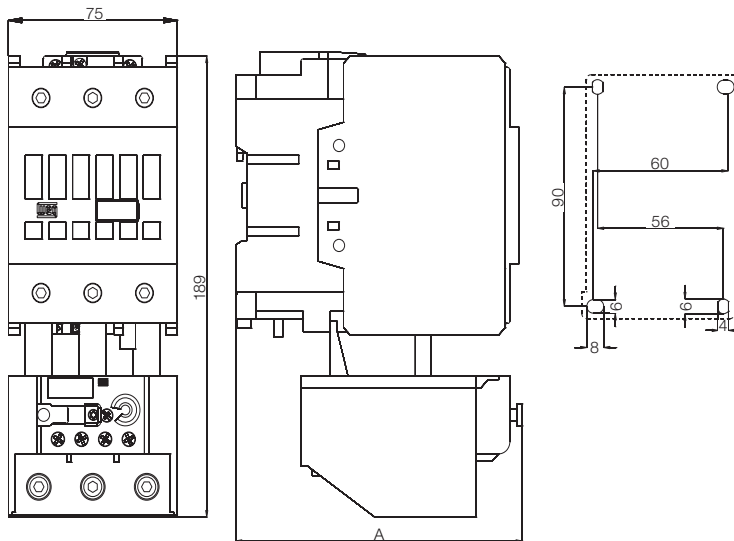

CWM95/105	A
AC coil	127.5
DC coil	127.5

Dimensions (mm)

CWM112 + RW117-2D

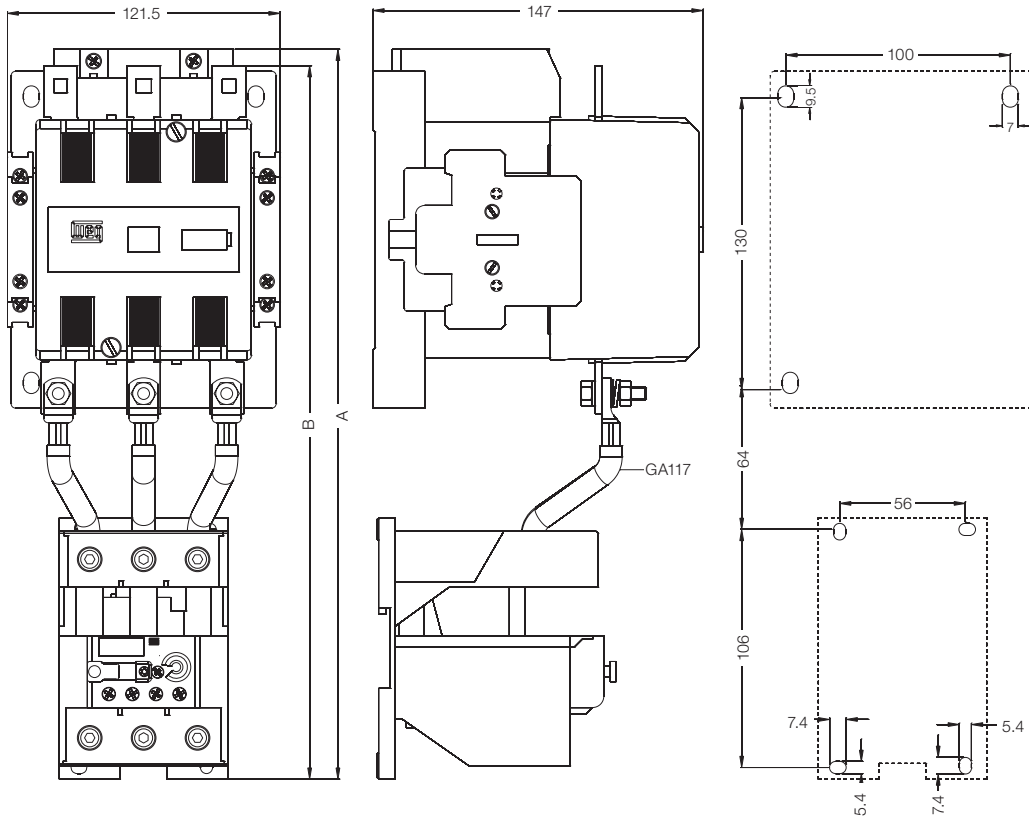

CWM112	A	B
Conventional coil	-	317.7
Electronic module	325	317.7

CWM112/150 + RW317

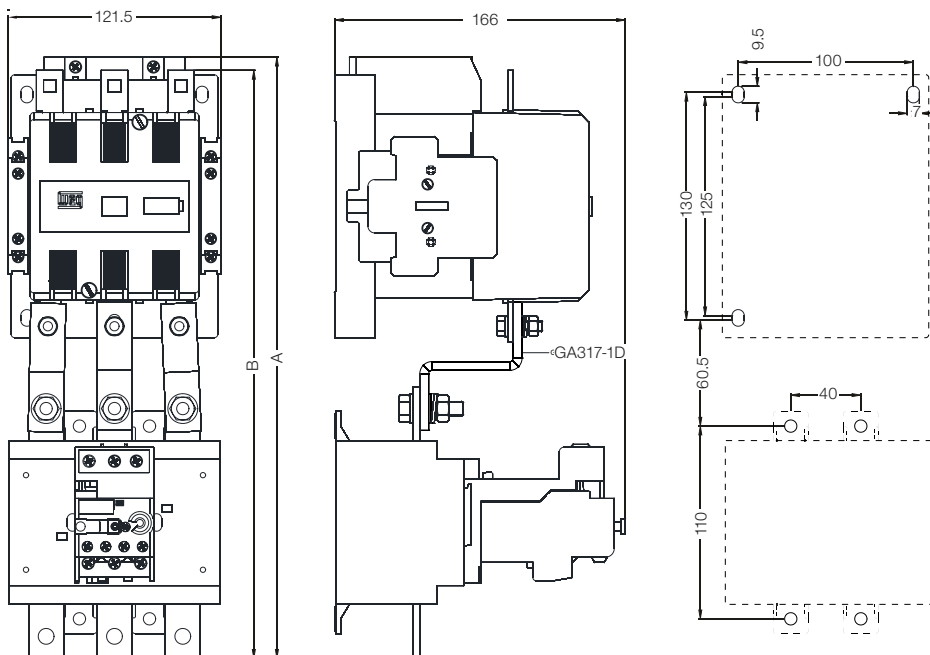

	A	B
CWM112 (conventional coil)	-	335.5
CWM112/150 electronic module)	343	335.5

Dimensions (mm)

CWM180/215 + RW317

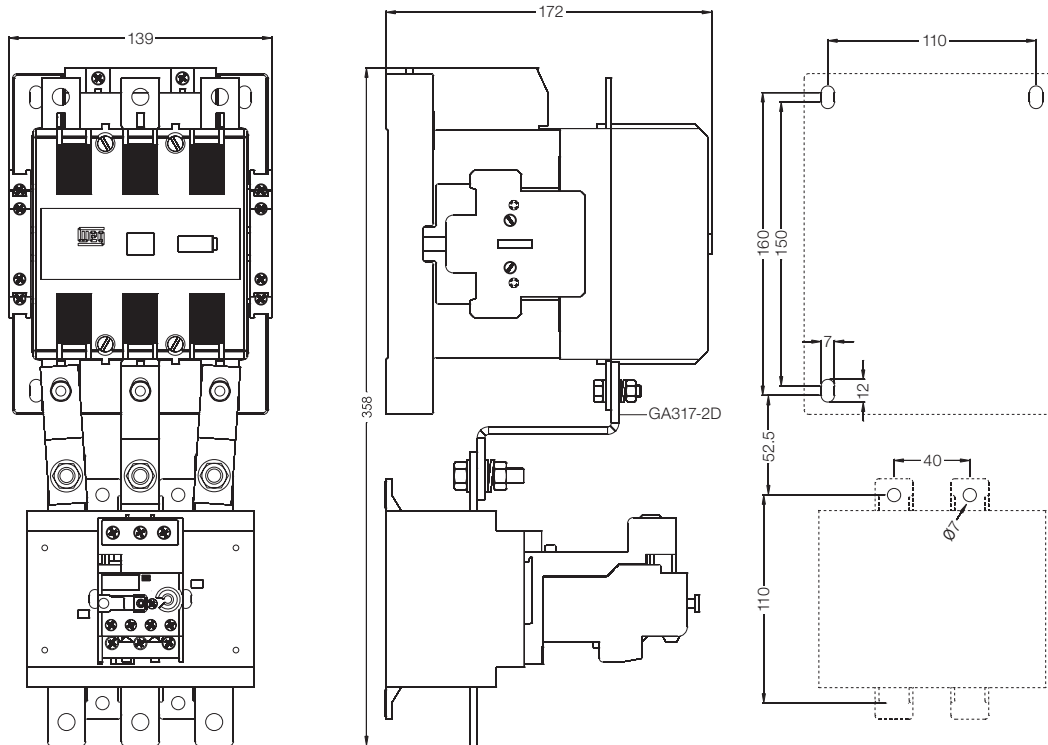

CWM250/300 + RW317

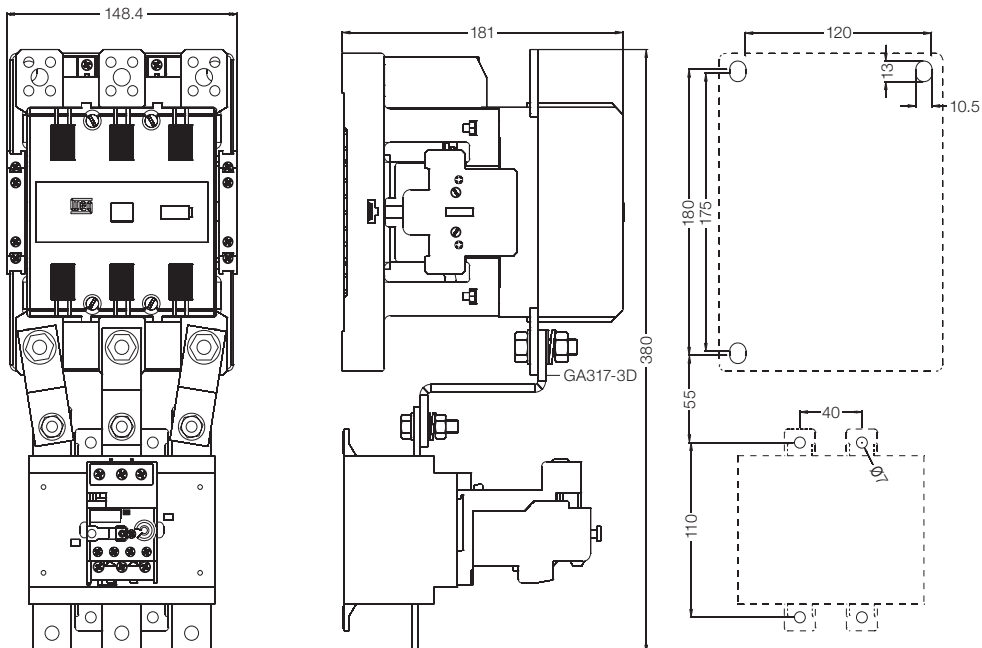

Dimensions (mm)

CWM400 + RW317

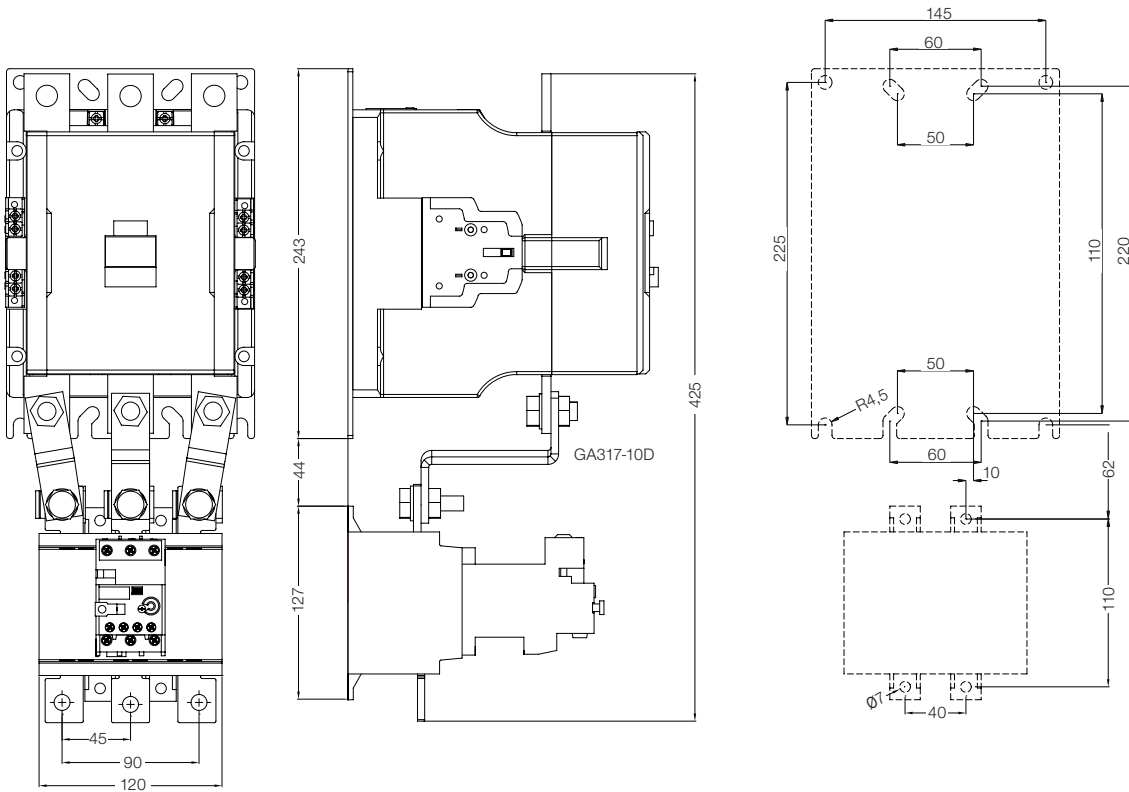

CWM450/560 + RW317

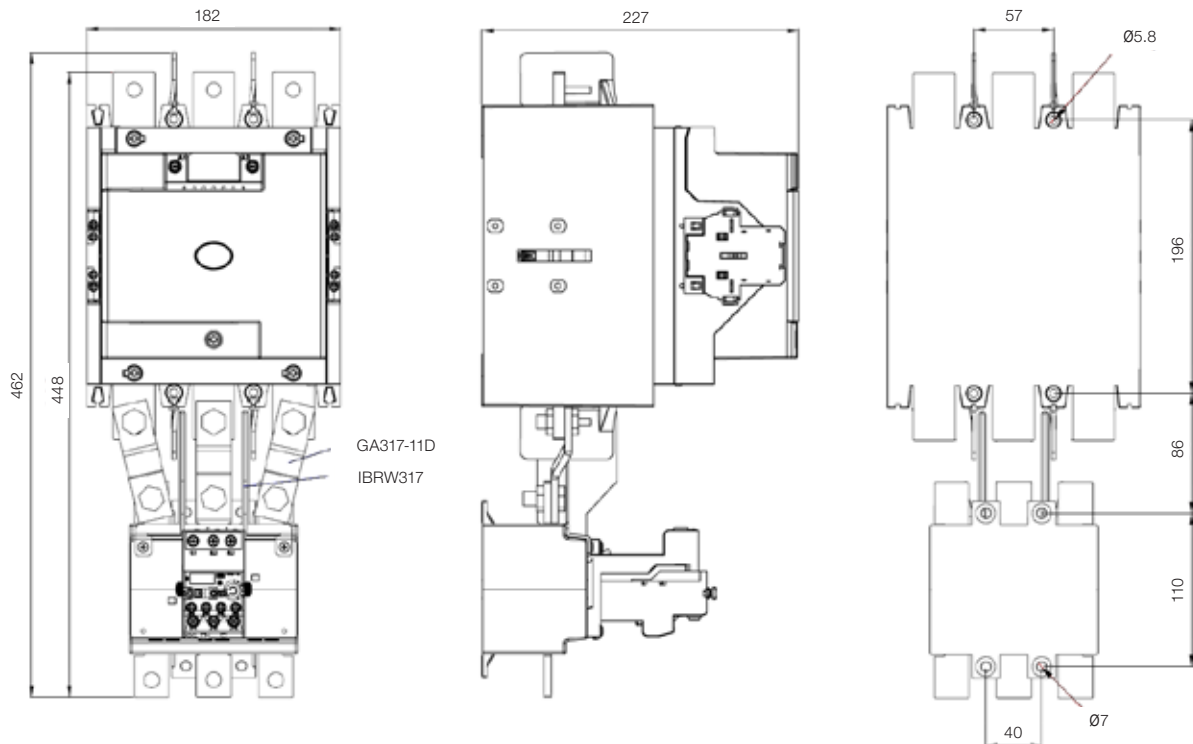

Dimensions (mm)

CWM450/560 + RW407

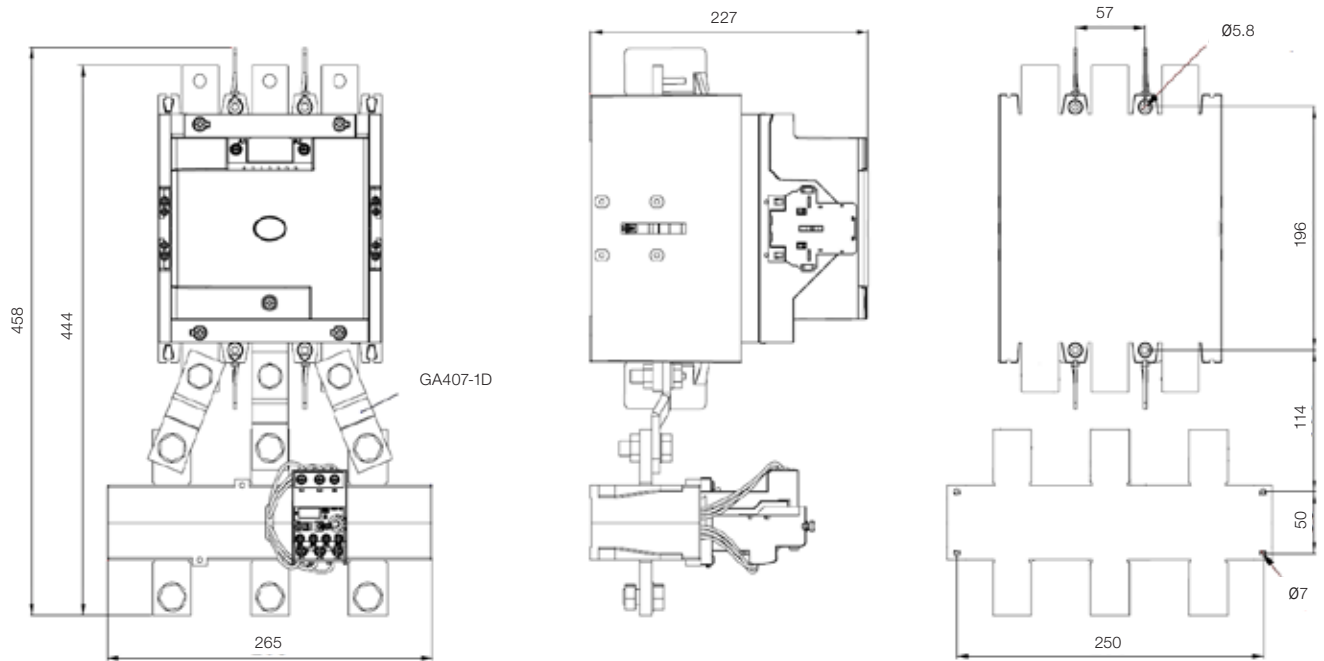



Global presence is essential, as much as understanding your needs.

Global Presence

With more than 30.000 employees worldwide, WEG is one of the largest electric motors, electronic equipments and systems manufacturers. We are constantly expanding our portfolio of products and services with expertise and market knowledge. We create integrated and customized solutions ranging from innovative products to complete after-sales service.

WEG's know-how guarantees our **RW Thermal Overload Relays** is the right choice for your application and business, assuring safety, efficiency and reliability.



Availability is to have a global support network



Partnership is to create solutions that suit your needs



Competitive edge is to unite technology and innovation



Know More



High performance and reliable products to improve your production process.



Excellence is to provide a whole solution in industrial automation that improves our customers productivity.

Visit: www.weg.net

 youtube.com/wegvideos

For WEG's worldwide
operations visit our website



www.weg.net



AUTOMATION

 +55 47 3276.4000

 automacao@weg.net

 Jaraguá do Sul - SC - Brazil

Cod: 50070227 | Rev: 03 | Date (m/a): 07/2020.

The values shown are subject to change without prior notice.

The information contained is reference values.