

15 to 2,500 kVA

Applications

- For general loads, including lighting, industrial and commercial applications

Specifications

- Meets DOE-2016 and C802 standards for energy efficiency
- 60 Hz operation
- Aluminum windings
- 150°C temperature rise
- 220°C insulation class standard
- NEMA3R rated enclosures standard
- Heat-cured ASA-61 gray powder coat finish
- Cores of high quality electrical steel
- Primary taps on most units
- Lugs provided for units up to and including 75 kVA on catalog items

Features, Functions, Benefits

- Large connection compartment for ease of wiring and installation
- Many sizes in stock and available for immediate shipment
- Quiet operation for installation flexibility
- Seismic certification for all units through 1,000 kVA



Standards

- Meets DOE-2016 standard Part 431, Subpart K for energy efficiency
- Meets NRCAN-2019 requirements, C802.2.18 Standard for energy efficiency
- Built in accordance with NEMA, ANSI, UL and CSA standards

Options and Accessories

- Other sizes, voltages and temperature rises available
- Copper windings
- CE Marked units available as custom
- Wall brackets available for units up to 75 kVA

Approvals



Enclosure Figures

Figure 22

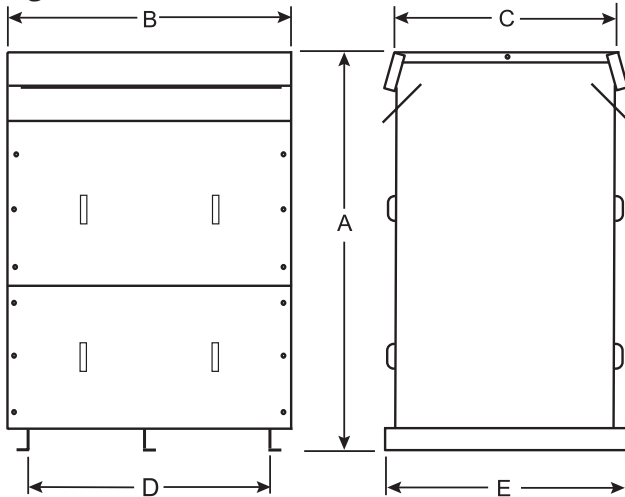
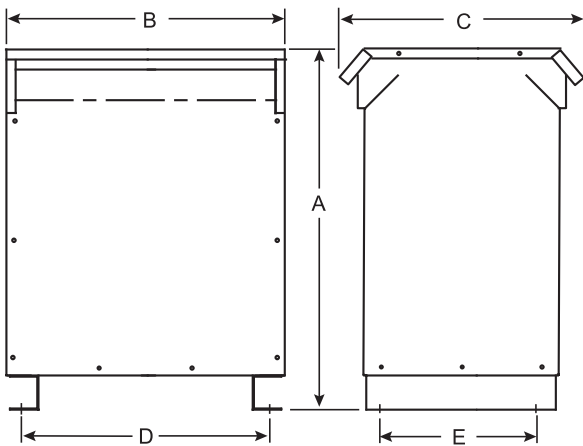

Figure 24



Model Numbers Defined*

423-TXXY-ABC

Three-Phase, Ventilated

Type

C802 compliant 5
DOE compliant 9

kVA Rating / XX		kVA Rating / XX	
15	16	250	30
20	17	300	31
25	18	333	32
30	19	400	33
37.5	20	500	34
45	21	667	35
50	22	750	36
75	23	833	37
100	24	1,000	39
112.5	25	1,250	43
150	26	1,500	47
167	27	2,000	51
200	28	2,500	53
225	29		

Primary	Secondary	
208	480Y/277	1
240	208Y/120	2
240	480Y/277	3
480	208Y/120	4
480	480Y/277	5
Special*		6
480	240 w/ 120 CT	7
208	208Y/120	8
600	208Y/120	9

Wiring

Aluminum 0
Copper 8

Temperature Rise

150°C Rise 0
115°C Rise 1
80°C Rise 8

Shields

No shield 0
Shield 5

Wall Mounting Bracket Kits

Part Number	Description	Max Unit Wgt (lbs)
223-7008-030	For 15 kVA units, 150°C rise	250
223-7008-075	For 16 to 75 kVA units, 150°C rise	750

Wall Mounting Bracket Kits with Drip Pans

400-4701-226	For Three Phase units, 19" width	750
400-4701-227	For Three Phase units, 22" width	750
400-4701-228	For Three Phase units, 25" width	750
400-4701-229	For Three Phase units, 27" width	750

Lugs

Part Number	kVA	Primary Lug	Qty	Secondary Lug	Qty
4PT-2007-LUG	15	#14 - 2	2	#2/0 - 6	2
4PT-2017-LUG	25	#14 - 2	2	250MCM - 6	2
4PT-2008-LUG	37.5	#14 - 2	2	350MCM - 6	2
4PT-2009-LUG	50	#2/0 - 6	2	600MCM - 6	2
4PT-2018-LUG	75	#2/0 - 6	2	600MCM - 6	4

*Suffix defined incrementally
* Not all features listed are compatible

Three-Phase General Purpose Transformers – DOE compliant

150°C Temperature Rise • Aluminum Windings • NEMA3R Enclosures

Taps: 15 to 300 kVA: 2 @ 2.5% FCAN & 4 @ 2.5% FCBN • 500 to 1,000 kVA: 2 @ 2.5% FCAN & 2 @ 2.5% FCBN

480V Delta — 208Y/120V										
kVA	Catalog Number	Enclosure Figure	Height (A) inches	Width (B) inches	Depth (C) inches	(D) inches	(E) inches	Est Ship Wgt (lbs)	Wiring Diagram	Wall Mounting Bracket Kit
15	423-9164-000	24	22	19	21	15.8	12	240	T480E	223-7008-030
30	423-9194-000	24	25	22	22	18.1	13	360	T480E	223-7008-075
45	423-9214-000	24	28	25	23.5	19.5	14.5	480	T480E	223-7008-075
75	423-9234-000	24	32	27	26	23.5	16	625	T480E	223-7008-075
112.5	423-9254-000	24	38	29	29	25.5	18	875	T480E	n/a
150	423-9264-000	24	42	33	32.5	30	21	1,125	T480E	n/a
225	423-9294-000	24	46	35	37	30.8	25	1,545	T480E	n/a
300	423-9314-000	24	52	35	37	30.8	25	1,895	T480E	n/a
500	423-9344-000	24	60	48	43.5	42	27	3,220	T480M	n/a
750	423-9364-000	22	72	52	44	47	42	4,250	T480M	n/a
1,000	423-9394-000	22	81	66	61	60.5	38.5	6,100	T480M	n/a

480V Delta — 240V Delta / 5% 120V CT										
15	423-9167-000 *	24	22	19	21	15.8	12	240	T480G	223-7008-030
30	423-9197-000 *	24	25	22	22	18.1	13	360	T480G	223-7008-075
45	423-9217-000 *	24	28	25	23.5	19.5	14.5	480	T480G	223-7008-075
75	423-9237-000 *	24	32	27	26	23.5	16	625	T480G	223-7008-075
112.5	423-9257-000 *	24	38	29	29	25.5	18	875	T480G	n/a
150	423-9267-000 *	24	42	33	32.5	30	21	1,125	T480G	n/a
225	423-9297-000 *	24	46	35	37	30.8	25	1,545	T480G	n/a
300	423-9317-000 *	24	52	35	37	30.8	25	1,895	T480G	n/a
500	423-9347-000 *	24	60	48	43.5	42	27	3,220	T480N	n/a
750	423-9367-000 *	22	72	52	44	47	42	4,250	T480N	n/a
1,000	423-9397-000 *	22	81	66	61	60.5	38.5	6,100	T480N	n/a

150°C Temperature Rise • Aluminum Windings • NEMA3R Enclosures

Taps: 2 @ 2.5% FCAN & 2 @ 2.5% FCBN

600V Delta — 208Y/120V										
15	423-9169-000	24	22	19	21	15.8	12	240	T600G	223-7008-030
30	423-9199-000	24	25	22	22	18.1	13	360	T600G	223-7008-075
45	423-9219-000	24	28	25	23.5	19.5	14.5	480	T600G	223-7008-075
75	423-9239-000	24	32	27	26	23.5	16	625	T600G	223-7008-075
112.5	423-9259-000	24	38	29	29	25.5	18	875	T600G	n/a
150	423-9269-000	24	42	33	32.5	30.0	21	1,125	T600G	n/a
225	423-9299-000	24	46	35	37	30.8	25	1,545	T600G	n/a
300	423-9319-000	24	52	35	37	30.8	25	1,895	T600G	n/a
500	423-9349-000	24	60	48	43.5	42.0	27	3,220	T600G	n/a
750	423-9369-000	22	72	52	44	47.0	42	4,250	T600G	n/a
1,000	423-9399-000	22	81	66	61	60.5	38.5	6,100	T600G	n/a

See website for additional kVA, copper windings and temperature options.

Housing dimensions subject to change without notice. Consult website or factory where dimensions are critical.

Use the "Find a Product" tool for detailed specification sheets.

For further information, contact an Application Engineer at 800-892-3755, technical_services@jeffersonelectric.com

* **CAUTION:** When using the 120V center tap for single-phase applications, the single-phase load should not exceed 5% of the three-phase kVA rating. Connect the X3 "high leg" to the "B" phase per NEC 384-3 (do not use X3 leg for 120V lighting). A separate single-phase transformer should be used if the single-phase load is in excess of 5%. Fuse input side per current NEC requirements.



2-4 Three-Phase Ventilated

Three-Phase General Purpose Transformers – NRCAN-2019, C802 Compliant

150°C Temperature Rise • Aluminum Windings • NEMA3R Enclosures

Taps: 15 to 300 kVA: 2 @ 2.5% FCAN & 4 @ 2.5% FCBN • 500 to 1,000 kVA: 2 @ 2.5% FCAN & 2 @ 2.5% FCBN

480V Delta — 208/120Y

kVA	Catalog Number	Enclosure Figure	Height (A) inches	Width (B) inches	Depth (C) inches	(D) inches	(E) inches	Est Ship Wgt (lbs)	Wiring Diagram	Wall Mounting Bracket Kit
15	423-5164-000	24	22	19	21	15.8	12	240	T480E	223-7008-030
30	423-5194-000	24	25	22	22	18.1	13	360	T480E	223-7008-075
45	423-5214-000	24	28	25	23.5	19.5	14.5	480	T480E	223-7008-075
75	423-5234-000	24	32	27	26	23.5	16	625	T480E	223-7008-075
112.5	423-5254-000	24	38	29	29	25.5	18	875	T480E	n/a
150	423-5264-000	24	42	33	32.5	30	21	1,125	T480E	n/a
225	423-5294-000	24	46	35	37	30.8	25	1,545	T480E	n/a
300	423-5314-000	24	52	35	37	30.8	25	1,895	T480E	n/a
500	423-5344-000	24	60	48	43.5	42	27	3,220	T480M	n/a
750	423-5364-000	22	72	52	44	47	42	4,250	T480M	n/a
1,000	423-5394-000	22	81	66	61	60.5	38.5	6,100	T480M	n/a

480V Delta — 240V Delta / 5% 120V CT

15	423-5167-000 *	24	22	19	21	15.8	12	240	T480G	223-7008-030
30	423-5197-000 *	24	25	22	22	18.1	13	360	T480G	223-7008-075
45	423-5217-000 *	24	28	25	23.5	19.5	14.5	480	T480G	223-7008-075
75	423-5237-000 *	24	32	27	26	23.5	16	625	T480G	223-7008-075
112.5	423-5257-000 *	24	38	29	29	25.5	18	875	T480G	n/a
150	423-5267-000 *	24	42	33	32.5	30	21	1,125	T480G	n/a
225	423-5297-000 *	24	46	35	37	30.8	25	1,545	T480G	n/a
300	423-5317-000 *	24	52	35	37	30.8	25	1,895	T480G	n/a
500	423-5347-000 *	24	60	48	43.5	42	27	3,220	T480G	n/a
750	423-5367-000 *	22	72	52	44	47	42	4,250	T480N	n/a
1,000	423-5397-000 *	22	81	66	61	60.5	38.5	6,100	T480N	n/a

150°C Temperature Rise • Aluminum Windings • NEMA3R Enclosures

Taps: 2 @ 2.5% FCAN & 2 @ 2.5% FCBN

600V Delta — 208Y/120V

15	423-5169-000	24	22	19	21	15.8	12	240	T600G	223-7008-030
30	423-5199-000	24	25	22	22	18.1	13	360	T600G	223-7008-075
45	423-5219-000	24	28	25	23.5	19.5	14.5	480	T600G	223-7008-075
75	423-5239-000	24	32	27	26	23.5	16	625	T600G	223-7008-075
112.5	423-5259-000	24	38	29	29	25.5	18	875	T600G	n/a
150	423-5269-000	24	42	33	32.5	30	21	1,125	T600G	n/a
225	423-5299-000	24	46	35	37	30.8	25	1,545	T600G	n/a
300	423-5319-000	24	52	35	37	30.8	25	1,895	T600G	n/a
500	423-5349-000	24	60	48	43.5	42	27	3,220	T600G	n/a
750	423-5369-000	22	72	52	44	47	42	4,250	T600G	n/a
1,000	423-5399-000	22	81	66	61	60.5	38.5	6,100	T600G	n/a

See website for additional kVA, copper windings and temperature options.

Housing dimensions subject to change without notice. Consult website or factory where dimensions are critical.

Use the "Find a Product" tool for detailed specification sheets.

For further information, contact an Application Engineer at 800-892-3755, technical_services@jeffersonelectric.com

* **CAUTION:** When using the 120V center tap for single-phase applications, the single-phase load should not exceed 5% of the three-phase kVA rating. Connect the X3 "high leg" to the "B" phase per NEC 384-3 (do not use X3 leg for 120V lighting). A separate single-phase transformer should be used if the single-phase load is in excess of 5%. Fuse input side per current NEC requirements.

Wiring Diagrams

T480E Wiring Diagram & Connections

Wiring Diagram

Primary: 480 Volts Delta
Secondary: 208Y/120 Volts

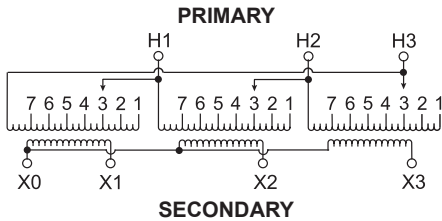

Connections

Primary Volts	On Each Coil Jumper Taps To	Primary Lines Connect To
504	1	H1, H2, H3
492	2	H1, H2, H3
480	3	H1, H2, H3
468	4	H1, H2, H3
456	5	H1, H2, H3
444	6	H1, H2, H3
432	7	H1, H2, H3
Secondary Volts	Secondary Lines Connect To	
208	X1, X2, X3	
120	Between X0 and X1 or X2 or X3	
1 phase		

T480G Wiring Diagram & Connections

Wiring Diagram

Primary: 480 Volts Delta
Secondary: 240 Volts Delta/120 Volts

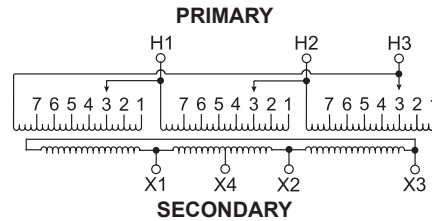

Connections

Primary Volts	On Each Coil Jumper Taps To	Primary Lines Connect To
504	1	H1, H2, H3
492	2	H1, H2, H3
480	3	H1, H2, H3
468	4	H1, H2, H3
456	5	H1, H2, H3
444	6	H1, H2, H3
432	7	H1, H2, H3
Secondary Volts	Secondary Lines Connect To	
240	X1, X2, X3	
120	X1 and X4 or X2 or X4	
1 phase		

T480M Wiring Diagram & Connections

Wiring Diagram

Primary: 480 Volts Delta
Secondary: 208Y/120 Volts

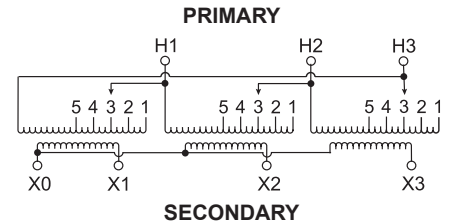

Connections

Primary Volts	On Each Coil Jumper Taps To	Primary Lines Connect To
504	1	H1, H2, H3
492	2	H1, H2, H3
480	3	H1, H2, H3
468	4	H1, H2, H3
456	5	H1, H2, H3
Secondary Volts	Secondary Lines Connect To	
208	X1, X2, X3	
120	Between X0 and X1 or X2 or X3	
1 phase		

T480N Wiring Diagram & Connections

Wiring Diagram

Primary: 480 Volts Delta
Secondary: 240 Volts Delta/120 Volts

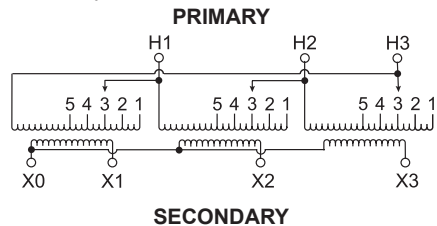

Connections

Primary Volts	On Each Coil Jumper Taps To	Primary Lines Connect To
504	1	H1, H2, H3
492	2	H1, H2, H3
480	3	H1, H2, H3
468	4	H1, H2, H3
456	5	H1, H2, H3
Secondary Volts	Secondary Lines Connect To	
240	X1, X2, X3	
120	X1 and X4 or X2 or X4	
1 phase		

T600G Wiring Diagram & Connections

Wiring Diagram

Primary: 600 Volts Delta
Secondary: 208Y/120 Volts

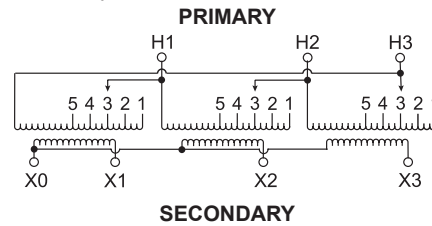

Connections

Primary Volts	On Each Coil Jumper Taps To	Primary Lines Connect To
630	1	H1, H2, H3
615	2	H1, H2, H3
600	3	H1, H2, H3
585	4	H1, H2, H3
570	5	H1, H2, H3
Secondary Volts	Secondary Lines Connect To	
208	X1, X2, X3	
120	Between X0 and X1 or X2 or X3	
1 phase		

More wiring diagrams can be found in catalog's appendix, section 15. Use the "Find a Product" tool on our website for detailed specification sheets. For further information, contact an Application Engineer at 800-892-3755, technical_services@jeffersonelectric.com

