

1 to 75 kVA

Applications

- Class I Division 2 units are used in hazardous locations to maintain a safe environment.

Specifications

- Class I Division 2, Groups A, B, C, D
- T3C temperature classification
- 60 Hz operation
- Single Phase: 1 – 25 kVA
- Three Phase: 3 – 75 kVA
- Aluminum windings
- 115°C temperature rise with 40°C ambient
- 180°C insulation class
- Encapsulated with electrical grade resin
- NEMA3R-rated enclosures
- Cores of high quality electrical steel
- Heat-cured ASA-61 gray powder coat finish

Features, Functions, Benefits

- Large connection compartment with knockouts for ease of wiring and installation
- Slotted mounting holes for quick and easy mounting
- Lifting hooks above 5 kVA
- Wall mount design through 25 kVA
- Seismic certification for all units



Standards

- Built in accordance with NEMA, ANSI, UL and CSA standards

Options and Accessories

- 50/60 Hz optional
- Other sizes, voltages available
- Copper windings
- 304 or 316 grade stainless steel enclosure to meet corrosion resistance requirements.
- CE Marked units available as custom

Approvals



Enclosure Figures

Figure 2

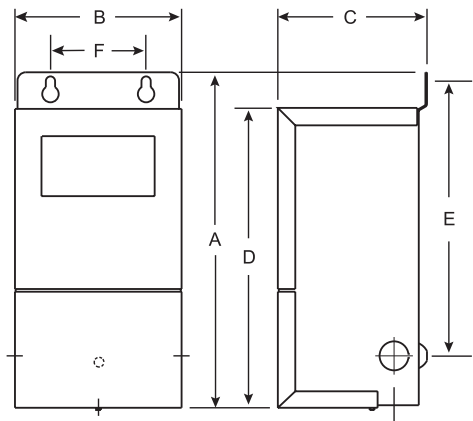

Figure 3

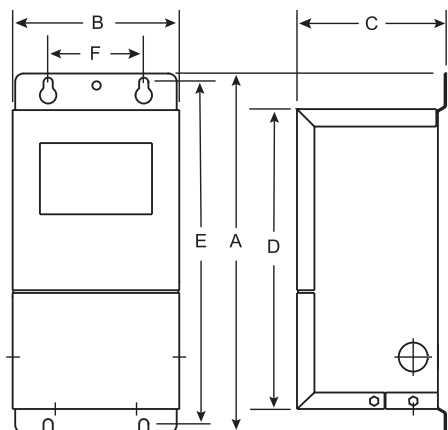
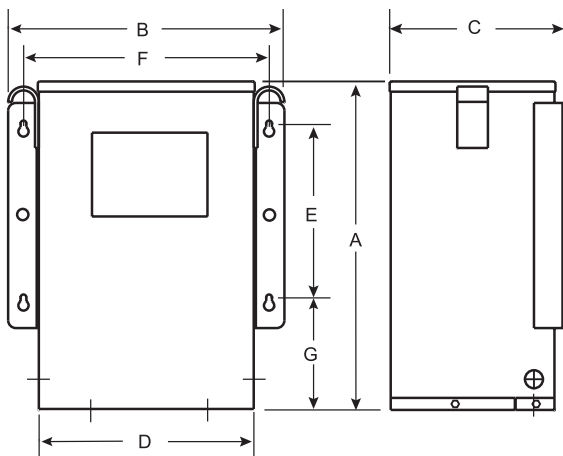

Figure 4



Model Numbers Defined *

411-2XXY-ABC

Single-Phase, Encapsulated Wall Mount		
Standard	411	
International	511	
Type		
Class I, Div 2	2	
kVA Rating / XX		
0.5 05	6.0 12	
0.75 06	7.5 13	
1.0 07	9.0 14	
1.5 08	10.0 15	
2.0 09	15.0 16	
3.0 10	20.0 17	
5.0 11	25.0 18	
Primary		
120x240	120/240	1
208	120/240	2
240x480	120/240	3
277	120/240	4
600	120/240	5
Specials*		6
480	120/240	7
Wiring		
Default		0
Copper		8
Temperature Rise, Shields all models 40°C ambient		
135°C Rise, no shield		0
135°C Rise, with shield		1
95°C Rise, no shield		2
95°C Rise, with shield		3
80°C Rise, no shield		4
80°C Rise, with shield		5
115°C Rise, no shield		6
115°C Rise, with shield		7
Taps		
No taps		0
2@2.5% FCBN		1
2@2.5% FCAN, 2@2.5 FCBN		2
4@2.5% FCBN		3
2@5% FCBN		4
1@5% FCAN, 1@5% FCBN		5
2@5% FCAN, 4@2.5 FCBN		6

* Suffix defined incrementally

* Not all features listed are compatible

Class I Division 2, Single Phase

115°C Temperature Rise, 40°C ambient

120 x 240V — 120/240V, Taps: None											
kVA	Catalog Number	Enclosure Figure	Height (A) inches	Width (B) inches	Depth (C) inches	(D) inches	(E) inches	(F) inches	(G) inches	Est Ship Wgt	Wiring Diagram
1.0	411-2071-060	2	10.2	5.1	4.6	9.1	8.4	2.25		19	S240A
2.0	411-2091-060	3	12.5	6.7	5.4	10.6	12	2.25		41	S240A
3.0	411-2101-060	3	14.6	7.6	7.2	12.7	14.1	3.5		68	S240A
5.0	411-2111-060	3	14.6	7.6	7.2	12.7	14.1	3.5		93	S240A
7.5	411-2131-060	4	16.1	13.5	8.6	10.6	8.25	12.0	5.5	130	S240A
10.0	411-2151-060	4	16.1	13.5	8.6	10.6	8.25	12.0	5.5	155	S240A
15.0	411-2161-060	4	21.1	16.5	10.1	13.7	12.5	15	6.3	255	S240A
25.0	411-2181-060	4	21.1	16.5	10.1	13.7	12.5	15	6.3	295	S240A
208V — 120/240V, Taps: None											
1.0	411-2072-060	2	10.2	5.1	4.6	9.1	8.4	2.3		19	S208A
2.0	411-2092-060	3	12.5	6.7	5.3	10.6	12.0	2.3		41	S208A
3.0	411-2102-060	3	14.6	7.6	7.2	12.7	14.1	3.5		68	S208A
5.0	411-2112-060	3	14.6	7.6	7.2	12.7	14.1	3.5		93	S208A
7.5	411-2132-060	4	16.1	13.5	8.6	10.6	8.3	12.0	5.5	130	S208A
10.0	411-2152-060	4	16.1	13.5	8.6	10.6	8.3	12.5	5.5	155	S208A
15.0	411-2162-060	4	21.1	16.5	10.1	13.7	12.5	15	6.3	255	S208A
25.0	411-2182-060	4	21.1	16.5	10.1	13.7	12.5	15	6.3	295	S208A
240 x 480V — 120/240V • Taps: None											
1.0	411-2073-060	2	10.2	5.1	4.6	9.1	8.4	2.3		19	S480A
2.0	411-2093-060	3	12.5	6.7	5.3	10.6	12.0	2.3		41	S480A
3.0	411-2103-060	3	14.6	7.6	7.2	12.7	14.1	3.5		68	S480A
5.0	411-2113-060	3	14.6	7.6	7.2	12.7	14.1	3.5		93	S480A
7.5	411-2133-060	4	16.1	13.5	8.6	10.6	8.3	12	5.5	130	S480A
10.0	411-2153-060	4	16.1	13.5	8.6	10.6	8.3	12	5.5	155	S480A
15.0	411-2163-060	4	21.1	16.5	10.1	13.7	12.5	15	6.3	255	S480A
25.0	411-2183-060	4	21.1	16.5	10.1	13.7	12.5	15	6.3	295r	S480A

See website for additional kVA, copper windings and temperature options.

Housing dimensions subject to change without notice. Consult website or factory where dimensions are critical.

Use the "Find a Product" tool for detailed specification sheets.

For further information, contact an Application Engineer at 800-892-3755, technical_services@jeffersonelectric.com

Class I Division 2, Single Phase

115°C Temperature Rise, 40°C ambient

240 x 480V — 120/240V • Taps: 2 @ 2.5% FCAN + 2 @ 2.5% FCBN											
kVA	Catalog Number	Enclosure Figure	Height (A) inches	Width (B) inches	Depth (C) inches	(D) inches	(E) inches	(F) inches	(G) inches	Est Ship Wgt	Wiring Diagram
1	411-2073-062	2	10.2	5.1	4.6	9.1	8.4	2.3		19	S480B
2	411-2093-062	3	12.5	6.7	5.3	10.6	12	2.3		41	S480B
3	411-2103-062	3	14.6	7.6	7.2	12.7	14.1	3.5		68	S480B
5	411-2113-062	3	14.6	7.6	7.2	12.7	14.1	3.5		93	S480B
7.5	411-2133-062	4	16.1	13.5	8.6	10.6	8.25	12.0	5.5	130	S480B
10	411-2153-062	4	16.1	13.5	8.6	10.6	8.25	12.0	5.5	155	S480B
15	411-2163-062	4	21.1	16.5	10.1	13.7	12.5	15.0	6.3	255	S480B
25	411-2183-062	4	21.1	16.5	10.1	13.7	12.5	15.0	6.3	295	S480B
277V — 120/240V • Taps: 2 @ 2.5% FCBN											
1	411-2074-061	2	10.2	5.1	4.6	9.1	8.4	2.3		19	S277A
2	411-2094-061	3	12.5	6.7	5.3	10.6	12.0	2.3		41	S277A
3	411-2104-061	3	14.6	7.6	7.2	12.7	14.1	3.5		68	S277A
5	411-2114-061	3	14.6	7.6	7.2	12.7	14.1	3.5		93	S277A
7.5	411-2134-061	4	16.1	13.5	8.6	10.6	8.25	12.0	5.5	130	S277A
10	411-2154-061	4	16.1	13.5	8.6	10.6	8.25	12.0	5.5	155	S277A
15	411-2164-061	4	21.1	16.5	10.1	13.7	12.5	15.0	6.3	255	S277A
25	411-2184-061	4	21.1	16.5	10.1	13.7	12.5	15.0	6.3	295	S277A
600V — 120/240V • Taps: 2 @ 2.5% FCAN + 2 @ 2.5% FCBN											
1	411-2075-062	2	10.2	5.1	4.6	9.1	8.4	2.3		19	S600A
2	411-2095-062	3	12.5	6.7	5.3	10.6	12.0	2.3		41	S600A
3	411-2105-062	3	14.6	7.6	7.2	12.7	14.1	3.5		68	S600A
5	411-2115-062	3	14.6	7.6	7.2	12.7	14.1	3.5		93	S600A
7.5	411-2135-062	4	16.1	13.5	8.6	10.6	8.25	12.0	5.5	130	S600A
10	411-2155-062	4	16.1	13.5	8.6	10.6	8.25	12.0	5.5	155	S600A
15	411-2165-062	4	21.1	16.5	10.1	13.7	12.5	15.0	6.3	255	S600A
25	411-2185-062	4	21.1	16.5	10.1	13.7	12.5	15.0	6.3	295	S600A

See website for additional kVA, copper windings and temperature options.

Housing dimensions subject to change without notice. Consult website or factory where dimensions are critical.

Use the "Find a Product" tool for detailed specification sheets.

For further information, contact an Application Engineer at 800-892-3755, technical_services@jeffersonelectric.com

Wiring Diagrams

S208A Wiring Diagram & Connections

Wiring Diagram

Primary: 208 Volts
Secondary: 120/240 Volts

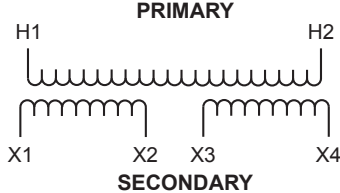

Connections

Primary Volts	Primary Lines Connect To	
208	H1, H2	
Secondary Volts	Interconnect	Secondary Lines Connect To
240	X2 to X3	X1, X4
120/240	X2 to X3	X1, X2, X4
120	X1 to X3 X2 to X4	X1, X4

S240A Wiring Diagram & Connections

Wiring Diagram

Primary: 120 x 240 Volts
Secondary: 120/240 Volts

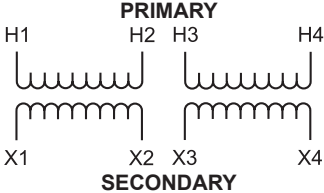

Connections

Primary Volts	Interconnect	Primary Lines Connect To
240	H2 to H3	H1, H4
120	H1 to H3 H2 to H4	H1, H4
Secondary Volts	Interconnect	Secondary Lines Connect To
240	X2 to X3	X1, X4
120/240	X2 to X3	X1, X2, X4
120	X1 to X3 X2 to X4	X1, X4

S277A Wiring Diagram & Connections

Wiring Diagram

Primary: 277 Volts
Secondary: 120/240 Volts

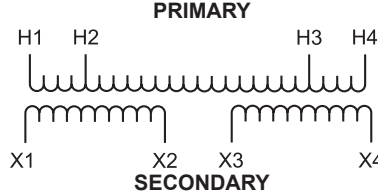

Connections

Primary Volts	Primary Lines Connect To	
277	H1, H4	
270	H1, H3	
263	H1, H4	
Secondary Volts	Interconnect	Secondary Lines Connect To
240	X2 to X3	X1, X4
120/240	X2 to X3	X1, X2, X4
120	X1 to X3 X2 to X4	X1, X4

S480A Wiring Diagram & Connections

Wiring Diagram

Primary: 240 x 480 Volts
Secondary: 120/240 Volts

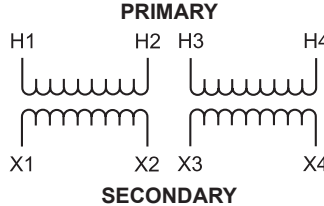

Connections

Primary Volts	Interconnect	Primary Lines Connect To
480	H2 to H3	H1, H4
240	H1 to H3 H2 to H4	H1, H4
Secondary Volts	Interconnect	Secondary Lines Connect To
240	X2 to X3	X1, X4
120/240	X2 to X3	X1, X2, X4
120	X1 to X3 X2 to X4	X1, X4

S600A Wiring Diagram & Connections

Wiring Diagram

Primary: 600 Volts
Secondary: 120/240 Volts

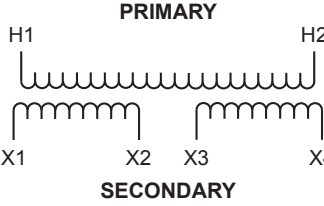

Connections

Primary Volts	Primary Lines Connect To	
600	H1, H2	
Secondary Volts	Interconnect	Secondary Lines Connect To
240	X2 to X3	X1, X4
120/240	X2 to X3	X1, X2, X4
120	X1 to X3 X2 to X4	X1, X4

S480B Wiring Diagram & Connections

Wiring Diagram

Primary: 240 x 480 Volts
Secondary: 120/240 Volts

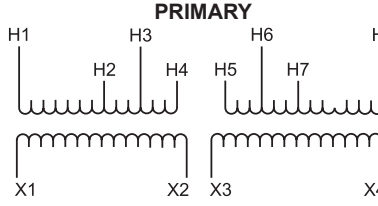

Connections

Primary Volts	Interconnect	Primary Lines Connect To
504	H4 to H5	H1 and H8
492	H3 to H5	H1 and H8
480	H3 to H6	H1 and H8
468	H2 to H6	H1 and H8
456	H2 to H7	H1 and H8
252	H1 to H5 H4 to H8	H1 and H8
240	H1 to H6 H3 to H8	H1 and H8
228	H1 to H7 H2 to H8	H1 and H8
Secondary Volts	Interconnect	Secondary Lines Connect To
240	X2 to X3	X1 and X4
120/240	X2 to X3	X1, X2, X4
120	X1 to X3 X2 to X4	X1, X4

More wiring diagrams can be found in catalog's appendix, section 15.
Use the "Find a Product" tool on our website for detailed specification sheets.
For further information, contact an Application Engineer at 800-892-3755,
technical_services@jeffersonelectric.com



Enclosure Figures

Figure 4

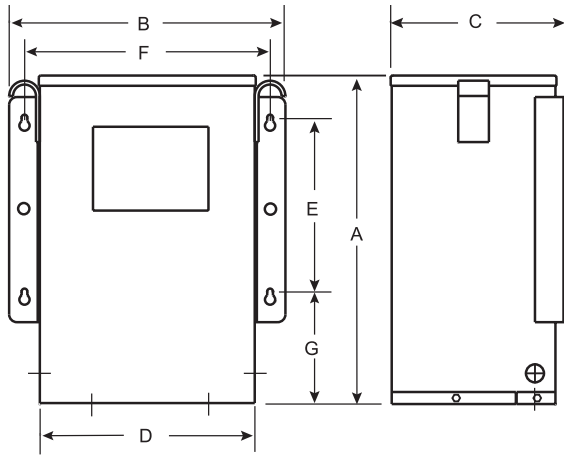
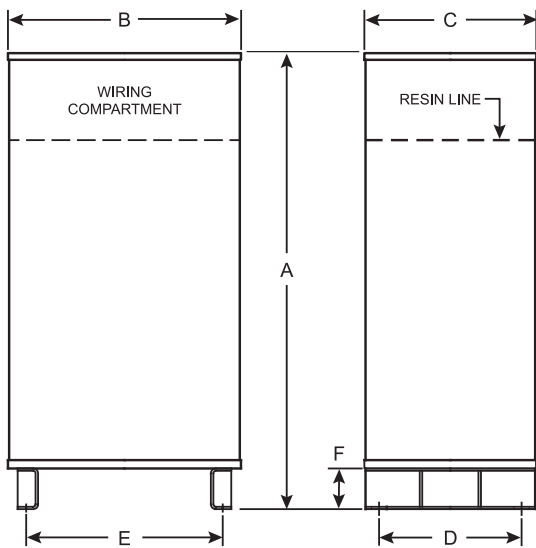

Figure 21



Model Numbers Defined*

413-2XXY-ABC

Three-Phase, Encapsulated		
Standard	413	
International	513	
Type		
Class I, Div 2	2	
kVA Rating / XX		
3	10	20
5	11	25
6	12	30
7.5	13	37.5
9	14	45
10	15	50
15	16	75
Primary		Secondary
208	480Y/277	1
240	208Y/120	2
240	480Y/277	3
480	208Y/120	4
480	480Y/277	5
Specials*		6
480	240	7
208	208Y/120	8
600	208Y/120	9
Wiring		
Default	0	
Copper	8	
Temperature Rise (40°C ambient)		
135°C Rise	0	
115°C Rise	1	
70°C Rise	7	
80°C Rise	8	
95°C Rise	9	
Shield		
Shield	0	
No shield	5	

* Suffix defined incrementally
 * Not all features listed are compatible

Class I Division 2, Three Phase

115°C Temperature Rise, 40°C ambient

208 Volts - 208/120 Volts • Taps: 2 @ 5% FCBN											
kVA	Catalog Number	Enclosure Figure	Height (A) inches	Width (B) inches	Depth (C) inches	(D) inches	(E) inches	(F) inches	(G) inches	Est Ship Wgt	Wiring Diagram
3	413-2108-010	4	13.1	15.1	8.1	12.3	5.25	13.6	5.5	110	T208H
6	413-2128-010	4	13.1	15.1	8.1	12.3	5.25	13.6	5.5	140	T208H
9	413-2148-010	4	15.1	19	9.1	16.1	8.25	17.5	5.1	190	T208H
15	413-2168-010	4	15.1	19	9.1	16.1	8.25	17.5	5.1	245	T208H
30	413-2198-010	21	33	23	9.5	7	20.5	3		890	T208H
45	413-2218-010	21	36	25	11	8.5	21.75	3		980	T208H
75	413-2238-010	21	37	25	12.5	10.5	22.5	3		1,050	T208H
208 Volts - 480/277 Volts • Taps: 2 @ 5% FCBN											
3	413-2101-010	4	13.1	15.1	8.1	12.3	5.25	13.6	5.5	110	T208A
6	413-2121-010	4	13.1	15.1	8.1	12.3	5.25	13.6	5.5	140	T208A
9	413-2141-010	4	15.1	19	9.1	16.1	8.25	17.5	5.1	190	T208A
15	413-2161-010	4	15.1	19	9.1	16.1	8.25	17.5	5.1	245	T208A
30	413-2191-010	21	33	23	9.5	7	20.5	3		890	T208A
45	413-2211-010	21	36	25	11	8.5	21.75	3		980	T208A
75	413-2231-010	21	37	25	12.5	10.5	22.5	3		1,050	T208A
240 Volts - 208Y/120 Volts • Taps: 2 @ 5% FCBN											
3	413-2102-010	4	13.1	15.1	8.1	12.3	5.25	13.6	5.5	110	T240A
6	413-2122-010	4	13.1	15.1	8.1	12.3	5.25	13.6	5.5	140	T240A
9	413-2142-010	4	15.1	19	9.1	16.1	8.25	17.5	5.1	190	T240A
15	413-2162-010	4	15.1	19	9.1	16.1	8.25	17.5	5.1	245	T240A
30	413-2192-010	21	33	23	9.5	7	20.5	3		890	T240A
45	413-2212-010	21	36	25	11	8.5	21.75	3		980	T240A
75	413-2232-010	21	37	25	12.5	10.5	22.5	3		1,050	T240A
240 Volts - 480/277 Volts • Taps: 2 @ 5% FCBN											
3	413-2103-010	4	13.1	15.1	8.1	12.3	5.25	13.6	5.5	110	T240G
6	413-2123-010	4	13.1	15.1	8.1	12.3	5.25	13.6	5.5	140	T240G
9	413-2143-010	4	15.1	19	9.1	16.1	8.25	17.5	5.1	190	T240G
15	413-2163-010	4	15.1	19	9.1	16.1	8.25	17.5	5.1	245	T240G
30	413-2193-010	21	33	23	9.5	7	20.5	3		890	T240G
45	413-2213-010	21	36	25	11	8.5	21.75	3		980	T240G
75	413-2233-010	21	37	25	12.5	10.5	22.5	3		1,050	T240G

See website for additional kVA, copper windings and temperature options.

Housing dimensions subject to change without notice. Consult website or factory where dimensions are critical.

Use the "Find a Product" tool for detailed specification sheets.

For further information, contact an Application Engineer at 800-892-3755, technical_services@jeffersonelectric.com

Class I Division 2, Three Phase

115°C Temperature Rise, 40°C ambient

480 Volts - 208Y/120 Volts • Taps: 2 @ 5% FCBN											
kVA	Catalog Number	Enclosure Figure	Height (A) inches	Width (B) inches	Depth (C) inches	(D) inches	(E) inches	(F) inches	(G) inches	Est Ship Wgt	Wiring Diagram
3	413-2104-010	4	13.1	15.1	8.1	12.3	5.25	13.6	5.5	110	T480A
6	413-2124-010	4	13.1	15.1	8.1	12.3	5.25	13.6	5.5	140	T480A
9	413-2144-010	4	15.1	19	9.1	16.1	8.25	17.5	5.1	190	T480A
15	413-2164-010	4	15.1	19	9.1	16.1	8.25	17.5	5.1	245	T480A
30	413-2194-010	21	33	23	9.5	7	20.5	3		890	T480A
45	413-2214-010	21	36	25	11	8.5	21.75	3		980	T480A
75	413-2234-010	21	37	25	12.5	10.5	22.5	3		1,050	T480A
480 Volts - 240 Volts • Taps: 2 @ 5% FCBN											
3	413-2107-010	4	13.1	15.1	8.1	12.3	5.25	13.6	5.5	110	T480B
6	413-2127-010	4	13.1	15.1	8.1	12.3	5.25	13.6	5.5	140	T480B
9	413-2147-010	4	15.1	19	9.1	16.1	8.25	17.5	5.1	190	T480B
15	413-2167-010	4	15.1	19	9.1	16.1	8.25	17.5	5.1	245	T480B
30	413-2197-010	21	33	23	9.5	7	20.5	3		890	T480B
45	413-2217-010	21	36	25	11	8.5	21.75	3		980	T480B
75	413-2237-010	21	37	25	12.5	10.5	22.5	3		1,050	T480B
480 Volts - 480/277 Volts • Taps: 2 @ 5% FCBN											
3	413-2105-010	4	13.1	15.1	8.1	12.3	5.25	13.6	5.5	110	T480C
6	413-2125-010	4	13.1	15.1	8.1	12.3	5.25	13.6	5.5	140	T480C
9	413-2145-010	4	15.1	19	9.1	16.1	8.25	17.5	5.1	190	T480C
15	413-2165-010	4	15.1	19	9.1	16.1	8.25	17.5	5.1	245	T480C
30	413-2195-010	21	33	23	9.5	7	20.5	3		890	T480C
45	413-2215-010	21	36	25	11	8.5	21.75	3		980	T480C
75	413-2235-010	21	37	25	12.5	10.5	22.5	3		1,050	T480C
600 Volts - 208/120 Volts • Taps: 2 @ 5% FCBN											
3	413-2109-010	4	13.1	15.1	8.1	12.3	5.25	13.6	5.5	110	T600A
6	413-2129-010	4	13.1	15.1	8.1	12.3	5.25	13.6	5.5	140	T600A
9	413-2149-010	4	15.1	19	9.1	16.1	8.25	17.5	5.1	190	T600A
15	413-2169-010	4	15.1	19	9.1	16.1	8.25	17.5	5.1	245	T600A
30	413-2199-010	21	33	23	9.5	7	20.5	3		890	T600A
45	413-2219-010	21	36	25	11	8.5	21.75	3		980	T600A
75	413-2239-010	21	37	25	12.5	10.5	22.5	3		1,050	T600A

See website for additional kVA, copper windings and temperature options.
 Housing dimensions subject to change without notice. Consult website or factory where dimensions are critical.
 Use the "Find a Product" tool for detailed specification sheets.
 For further information, contact an Application Engineer at 800-892-3755, technical_services@jeffersonelectric.com

Wiring Diagrams

T208A Wiring Diagram & Connections

Wiring Diagram

Primary: 208 Volts Delta
Secondary: 480Y/277 Volts

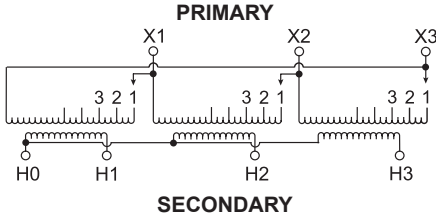

Connections

Primary Volts	On Each Coil Jumper Taps To	Primary Lines Connect To
208	1	X1, X2, X3
198	2	X1, X2, X3
187	3	X1, X2, X3
Secondary Volts	Secondary Lines Connect To	
480	H1, H2, H3	
277	Between H0 and H1 or H2 or H3	
1 Phase		

T208H Wiring Diagram & Connections

Wiring Diagram

Primary: 208 Volts Delta
Secondary: 208Y/120 Volts

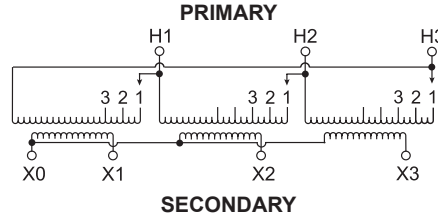

Connections

Primary Volts	On Each Coil Jumper Taps To	Primary Lines Connect To
208	1	H1, H2, H3
198	2	H1, H2, H3
187	3	H1, H2, H3
Secondary Volts	Secondary Lines Connect To	
208	X1, X2, X3	
120	Between X0 and X1 or X2 or X3	
1 Phase		

T240A Wiring Diagram & Connections

Wiring Diagram

Primary: 240 Volts Delta
Secondary: 208Y/120 Volts

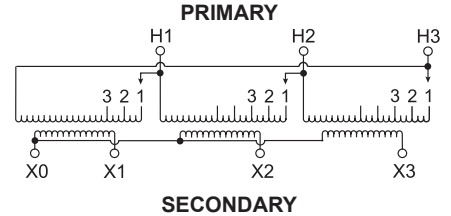

Connections

Primary Volts	On Each Coil Jumper Taps To	Primary Lines Connect To
240	1	H1, H2, H3
228	2	H1, H2, H3
216	3	H1, H2, H3
Secondary Volts	Secondary Lines Connect To	
208	X1, X2, X3	
120	Between X0 and X1 or X2 or X3	
1 Phase		

T240G Wiring Diagram & Connections

Wiring Diagram

Primary: 240 Volts Delta
Secondary: 480Y/277 Volts

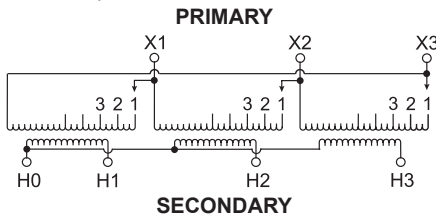

Connections

Primary Volts	On Each Coil Jumper Taps To	Primary Lines Connect To
240	1	X1, X2, X3
228	2	X1, X2, X3
216	3	X1, X2, X3
Secondary Volts	Secondary Lines Connect To	
480	H1, H2, H3	
277	Between H0 and H1 or H2 or H3	
1 Phase		

More wiring diagrams can be found in catalog's appendix, section 15. Use the "Find a Product" tool on our website for detailed specification sheets. For further information, contact an Application Engineer at 800-892-3755, technical_services@jeffersonelectric.com

Wiring Diagrams

T480A Wiring Diagram & Connections

Wiring Diagram

Primary: 480 Volts Delta
Secondary: 208Y/120 Volts

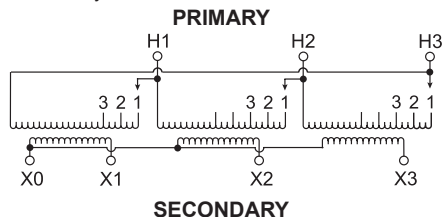

Connections

Primary Volts	On Each Coil Jumper Taps To	Primary Lines Connect To
480	1	H1, H2, H3
456	2	H1, H2, H3
432	3	H1, H2, H3
Secondary Volts	Secondary Lines Connect To	
208	X1, X2, X3	
120	Between X0 and X1 or X2 or X3	
1 Phase		

T480B Wiring Diagram & Connections

Wiring Diagram

Primary: 480 Volts Delta
Secondary: 240 Volts Delta

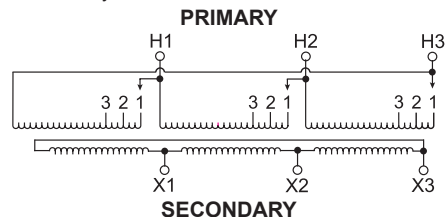

Connections

Primary Volts	On Each Coil Jumper Taps To	Primary Lines Connect To
480	1	H1, H2, H3
456	2	H1, H2, H3
432	3	H1, H2, H3
Secondary Volts	Secondary Lines Connect To	
240	X1, X2, X3	

T480C Wiring Diagram & Connections

Wiring Diagram

Primary: 480 Volts Delta
Secondary: 480Y/277 Volts

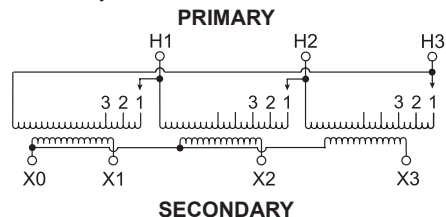

Connections

Primary Volts	On Each Coil Jumper Taps To	Primary Lines Connect To
480	1	H1, H2, H3
456	2	H1, H2, H3
432	3	H1, H2, H3
Secondary Volts	Secondary Lines Connect To	
480	X1, X2, X3	
277	Between X0 and X1 or X2 or X3	
1 Phase		

T600A Wiring Diagram & Connections

Wiring Diagram

Primary: 600 Volts Delta
Secondary: 208Y/120 Volts

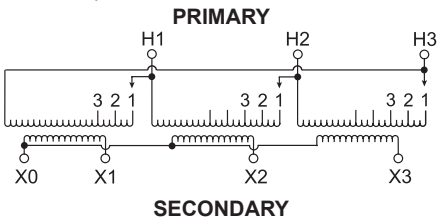

Connections

Primary Volts	On Each Coil Jumper Taps To	Primary Lines Connect To
600	1	H1, H2, H3
570	2	H1, H2, H3
540	3	H1, H2, H3
Secondary Volts	Secondary Lines Connect To	
208	X1, X2, X3	
120	Between X0 and X1 or X2 or X3	
1 phase		

More wiring diagrams can be found in catalog's appendix, section 15. Use the "Find a Product" tool on our website for detailed specification sheets. For further information, contact an Application Engineer at 800-892-3755, technical_services@jeffersonelectric.com