



Customer information packet

EM3556T-5

1HP, 1170RPM, 3PH, 60HZ, 145T, 3526M, TEFC, F1

Class - None

Division - Not Applicable

Specifications

| | |
|--------------------------------|---|
| Enclosure | TEFC |
| Frame | 145T |
| Frame Material | Steel |
| Frequency | 60.00 Hz |
| Motor Letter Type | Three Phase |
| Output @ Frequency | 1.000 HP @ 60 HZ |
| Phase | 3 |
| Synchronous Speed @ Frequency | 1200 RPM @ 60 HZ |
| Voltage @ Frequency | 575.0 V @ 60 HZ |
| XP Class and Group | None |
| XP Division | Not Applicable |
| Agency Approvals | NEMA PREMIUM NEMA_PREMIUM UR CSA EEV |
| Ambient Temperature | 40 °C |
| Auxillary Box | No Auxillary Box |
| Auxillary Box Lead Termination | None |
| Base Indicator | Rigid |
| Bearing Grease Type | Polyrex EM (-20F +300F) |
| Blower | None |
| Current @ Voltage | 1.400 A @ 575.0 V |
| Design Code | B |
| Drip Cover | No Drip Cover |
| Duty Rating | CONT |
| Efficiency @ 100% Load | 82.5 % |
| Electrically Isolated Bearing | Not Electrically Isolated |
| Feedback Device | NO FEEDBACK |
| Front Shaft Indicator | None |
| Heater Indicator | No Heater |
| High Voltage Full Load Amps | 1.4 a |
| Insulation Class | F |

Part detail

| | |
|--------------|------------|
| Revision | - |
| Type | AC |
| Mech. spec. | 35AA001 |
| Base | |
| Status | PRD/A |
| Elec. spec. | 35WGG117 |
| Layout | 35LYAA001 |
| Eff. date | 12-12-2022 |
| CD Diagram | CD0006 |
| Poles | 06 |
| Leads | 3#18 Y |
| Proprietary | False |
| Created date | 09-09-2022 |

| | |
|--------------------------------------|---------------------|
| Inverter Code | Inverter Ready |
| KVA Code | J |
| Lifting Lugs | No Lifting Lugs |
| Locked Bearing Indicator | No Locked Bearing |
| Motor Lead Quantity/Wire Size | 3 @ 18 AWG |
| Motor Lead Termination | Flying Leads |
| Motor Standards | NEMA |
| Motor Type | 3526M |
| Mounting Arrangement | F1 |
| Number of Poles | 6 |
| Overall Length | 13.31 IN |
| Power Factor | 65 |
| Product Family | General Purpose |
| Pulley End Bearing Type | Ball |
| Pulley Face Code | Standard |
| Pulley Shaft Indicator | Standard |
| Rodent Screen | None |
| Service Factor | 1.15 |
| Shaft Diameter | 0.875 IN |
| Shaft Ground Indicator | No Shaft Grounding |
| Shaft Rotation | Reversible |
| Shaft Slinger Indicator | No Slinger |
| Speed | 1170 rpm |
| Speed Code | Single Speed |
| Starting Method | Direct on line |
| Thermal Device - Bearing | None |
| Thermal Device - Winding | None |
| Vibration Sensor Indicator | No Vibration Sensor |
| Winding Thermal 1 | None |
| Winding Thermal 2 | None |

Nameplate

| NP3441L | | | | | | | | | |
|----------------------------------|---------------|-----------------------|-------------|------------|---|-----------|-----|--|--|
| CAT.NO. | | | | | | | | | |
| SPEC. | 35AA001G117G1 | | | | | | | | |
| HP | 1 | | | | | | | | |
| VOLTS | 575 | | | | | | | | |
| AMP | 1.4 | | | | | | | | |
| RPM | 1170 | | | | | | | | |
| FRAME | 145T | | HZ | 60 | | PH | 3 | | |
| SER.F. | 1.15 | CODE | J | DES | B | CL | F | | |
| NEMA-NOM-EFF | 82.5 | PF | 65 | | | | | | |
| RATING | 40C AMB-CONT | | | | | | | | |
| CC | 010A | USABLE AT 208V | | | | | N/A | | |
| DE | 6205 | ODE | 6203 | | | | | | |
| ENCL | TEFC | SN | SFA 4.2/2.1 | | | | | | |
| VPWM INVERTER READY | | | | | | | | | |
| CT6-60H(10:1)VT3-60H(20:1 | | | | | | | | | |
| SFA 1.5 | | | | | | | | | |

AC Induction Motor Performance Data

Record # 82331

Typical performance - not guaranteed values

| Winding: 35WGG117-R001 | | Type: 3526M | | Enclosure: TEFC | |
|------------------------|-------------------|--------------|---|-----------------|--------------------------|
| Nameplate Data | | | 575 V, 60 Hz: Single Voltage Motor | | |
| Rated Output (HP) | | 1 | Full Load Torque | | 4.48 LB-FT |
| Volts | | 575 | Start Configuration | | direct on line |
| Full Load Amps | | 1.34 | Breakdown Torque | | 11.99 LB-FT |
| R.P.M. | | 1169 | Pull-up Torque | | 7.12 LB-FT |
| Hz | 60 Phase | 3 | Locked-rotor Torque | | 8.69 LB-FT |
| NEMA Design Code | B KVA Code | J | Starting Current | | 7.31 A |
| Service Factor (S.F.) | | 1.15 | No-load Current | | 0.825 A |
| NEMA Nom. Eff. | 82.5 Power Factor | 67 | Line-line Res. @ 25°C | | 32.9 Ω |
| Rating - Duty | | 40C AMB-CONT | Temp. Rise @ Rated Load | | 46°C |
| S.F. Amps | | | Temp. Rise @ S.F. Load | | 56°C |
| | | | Locked-rotor Power Factor | | 48.5 |
| | | | Rotor inertia | | 0.189 lb-ft ² |

Load Characteristics 575 V, 60 Hz, 1 HP

| % of Rated Load | 25 | 50 | 75 | 100 | 125 | 150 | S.F. |
|-----------------|-------|-------|------|------|------|------|------|
| Power Factor | 29 | 47 | 59 | 67 | 72 | 75 | 70 |
| Efficiency | 73.4 | 81.8 | 83.4 | 83.1 | 81.6 | 79.1 | 82.2 |
| Speed | 1193 | 1186 | 1178 | 1169 | 1159 | 1147 | 1163 |
| Line amperes | 0.865 | 0.976 | 1.13 | 1.34 | 1.59 | 1.88 | 1.49 |

ABB Motors and Mechanical Inc.

WINDING # 35WGG117

Typical performance - not guaranteed values.

1 HP 3 PH 60 HZ 1169 RPM 575 V 3526M

TORQUES (LB-FT): PO=11.99 PU=7.12 LR=8.69 LRA=7.31

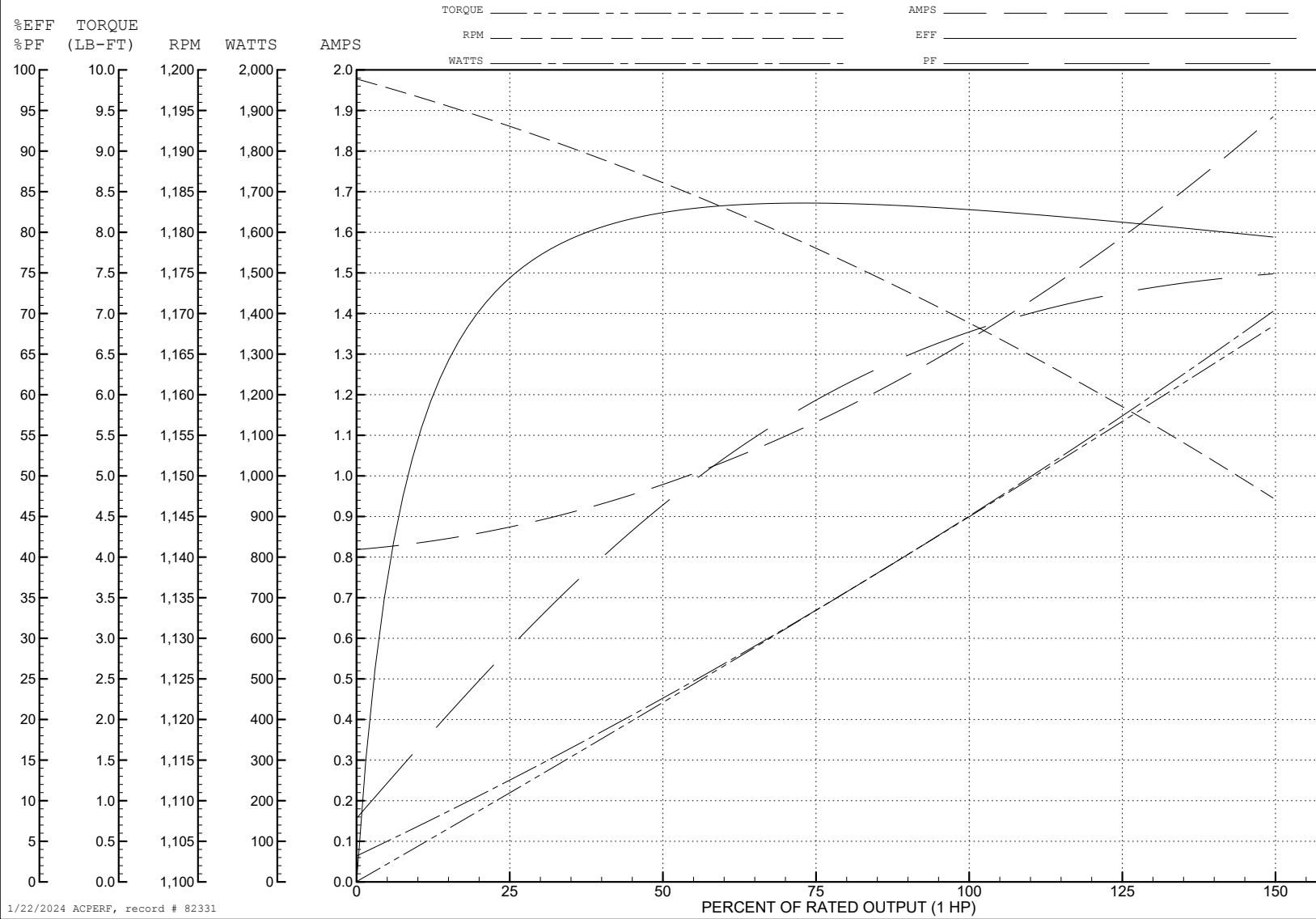

1/22/2024 ACPERF, record # 82331

AC Induction Motor Performance Data

Record # 95152

Typical performance - not guaranteed values

| Winding: 35WGG117-R006 | | Type: 3526M | Enclosure: OPAO | |
|------------------------|-------------------|---------------------------|---|--|
| Nameplate Data | | | 575 V, 60 Hz: Single Voltage Motor | |
| Rated Output (HP) | 1 AIR OVER | Full Load Torque | 4.48 LB-FT | |
| Volts | 575//480 | Start Configuration | direct on line | |
| Full Load Amps | 1.35//1.55 | Breakdown Torque | 12 LB-FT | |
| R.P.M. | 1170//960 | Pull-up Torque | 7.1 LB-FT | |
| Hz | 60//50 Phase | Locked-rotor Torque | 8.7 LB-FT | |
| NEMA Design Code | B KVA Code | Starting Current | 7.3 A | |
| Service Factor (S.F.) | 1.15 | No-load Current | 0.825 A | |
| NEMA Nom. Eff. | 82.5 Power Factor | Line-line Res. @ 25°C | 32.9 Ω | |
| Rating - Duty | 40C AMB-CONT | Temp. Rise @ Rated Load | 46°C | |
| S.F. Amps | 1.5//1.75 | Temp. Rise @ S.F. Load | 56°C | |
| | | Locked-rotor Power Factor | 48.5 | |
| | | Rotor inertia | 0.189 lb-ft ² | |

Load Characteristics 575 V, 60 Hz, 1 HP

| % of Rated Load | 25 | 50 | 75 | 100 | 125 | 150 | S.F. |
|-----------------|-------|-------|------|------|------|------|------|
| Power Factor | 29 | 47 | 59 | 67 | 72 | 75 | 70 |
| Efficiency | 73.4 | 81.8 | 83.4 | 83.1 | 81.6 | 79.1 | 82.2 |
| Speed | 1193 | 1186 | 1178 | 1169 | 1159 | 1147 | 1163 |
| Line amperes | 0.865 | 0.976 | 1.13 | 1.34 | 1.59 | 1.88 | 1.49 |

ABB Motors and Mechanical Inc.

WINDING # 35WGG117

Typical performance - not guaranteed values.

1 HP 3 PH 60 HZ 1169 RPM 575 V 3526M

TORQUES (LB-FT): PO=12 PU=7.1 LR=8.7 LRA=7.3

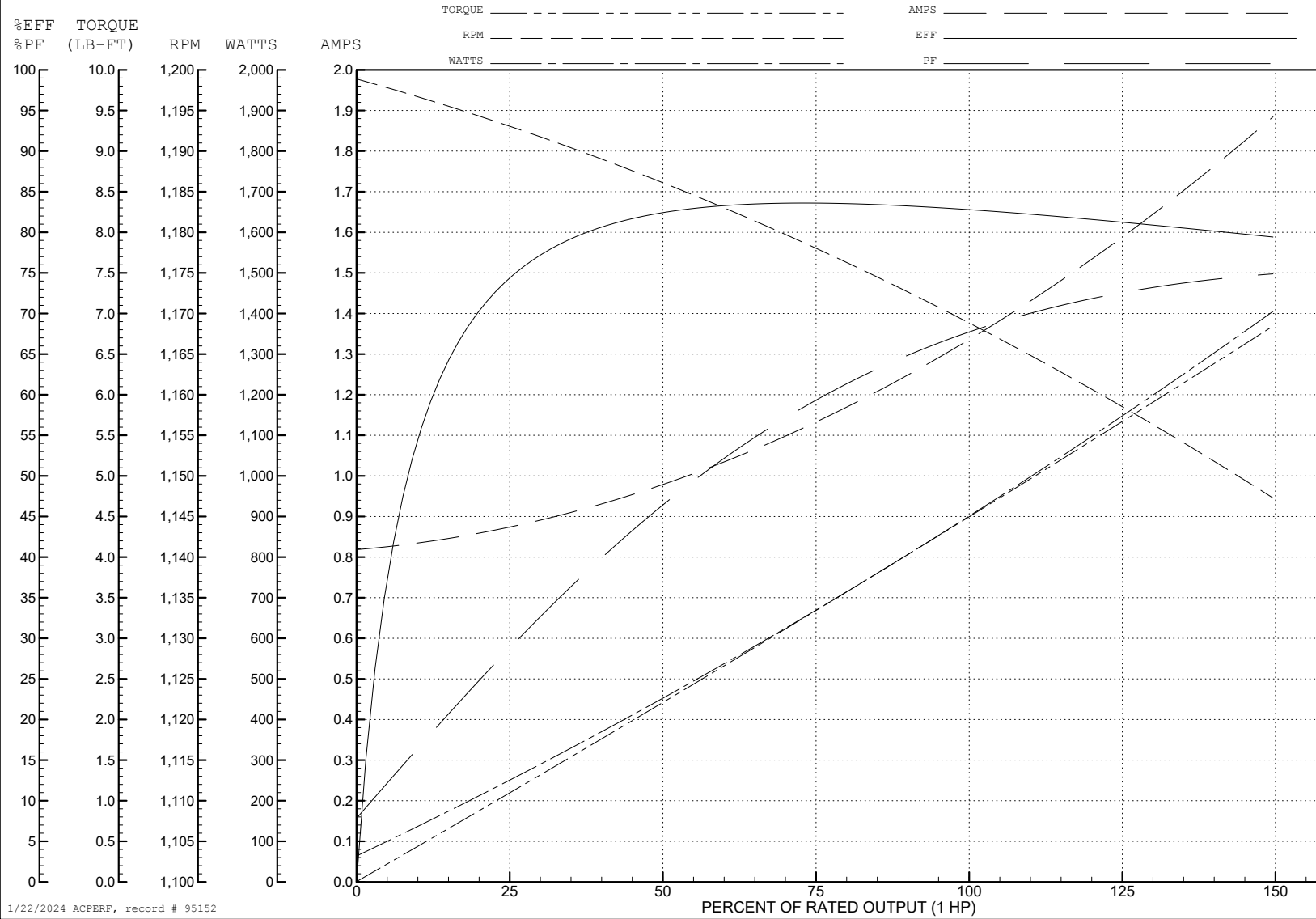

1/22/2024 ACPERF, record # 95152

AC Induction Motor Performance Data

Record # 95154

Typical performance - not guaranteed values

| Winding: 35WGG117-R006 | | Type: 3526M | Enclosure: OPAO | |
|------------------------|-------------------|---------------------|---|--------------------------|
| Nameplate Data | | | 480 V, 50 Hz: Single Voltage Motor | |
| Rated Output (HP) | 1 AIR OVER | Full Load Torque | 5.44 LB-FT | |
| Volts | 575//480 | Start Configuration | direct on line | |
| Full Load Amps | 1.35//1.55 | Breakdown Torque | 11.4 LB-FT | |
| R.P.M. | 1170//960 | Pull-up Torque | 7.2 LB-FT | |
| Hz | 60//50 Phase | 3 | Locked-rotor Torque | 8.8 LB-FT |
| NEMA Design Code | B KVA Code | J | Starting Current | 7 A |
| Service Factor (S.F.) | | 1.15 | No-load Current | 0.826 A |
| NEMA Nom. Eff. | 82.5 Power Factor | 67 | Line-line Res. @ 25°C | 32.9 Ω |
| Rating - Duty | | 40C AMB-CONT | Temp. Rise @ Rated Load | 62°C |
| S.F. Amps | | 1.5//1.75 | Temp. Rise @ S.F. Load | 79°C |
| | | | Locked-rotor Power Factor | 53.9 |
| | | | Rotor inertia | 0.189 lb-ft ² |

Load Characteristics 480 V, 50 Hz, 1 HP

| % of Rated Load | 25 | 50 | 75 | 100 | 125 | 150 | S.F. |
|-----------------|-------|------|------|------|------|------|------|
| Power Factor | 34 | 53 | 65 | 72 | 76 | 77 | 74 |
| Efficiency | 74.5 | 81.8 | 82 | 80.5 | 77.5 | 72.9 | 78.7 |
| Speed | 992 | 983 | 974 | 962 | 949 | 930 | 954 |
| Line amperes | 0.879 | 1.03 | 1.25 | 1.54 | 1.91 | 2.38 | 1.76 |

ABB Motors and Mechanical Inc.

WINDING # 35WGG117

Typical performance - not guaranteed values.

1 HP 3 PH 50 HZ 962 RPM 480 V 3526M

TORQUES (LB-FT): PO=11.4 PU=7.2 LR=8.8 LRA=7

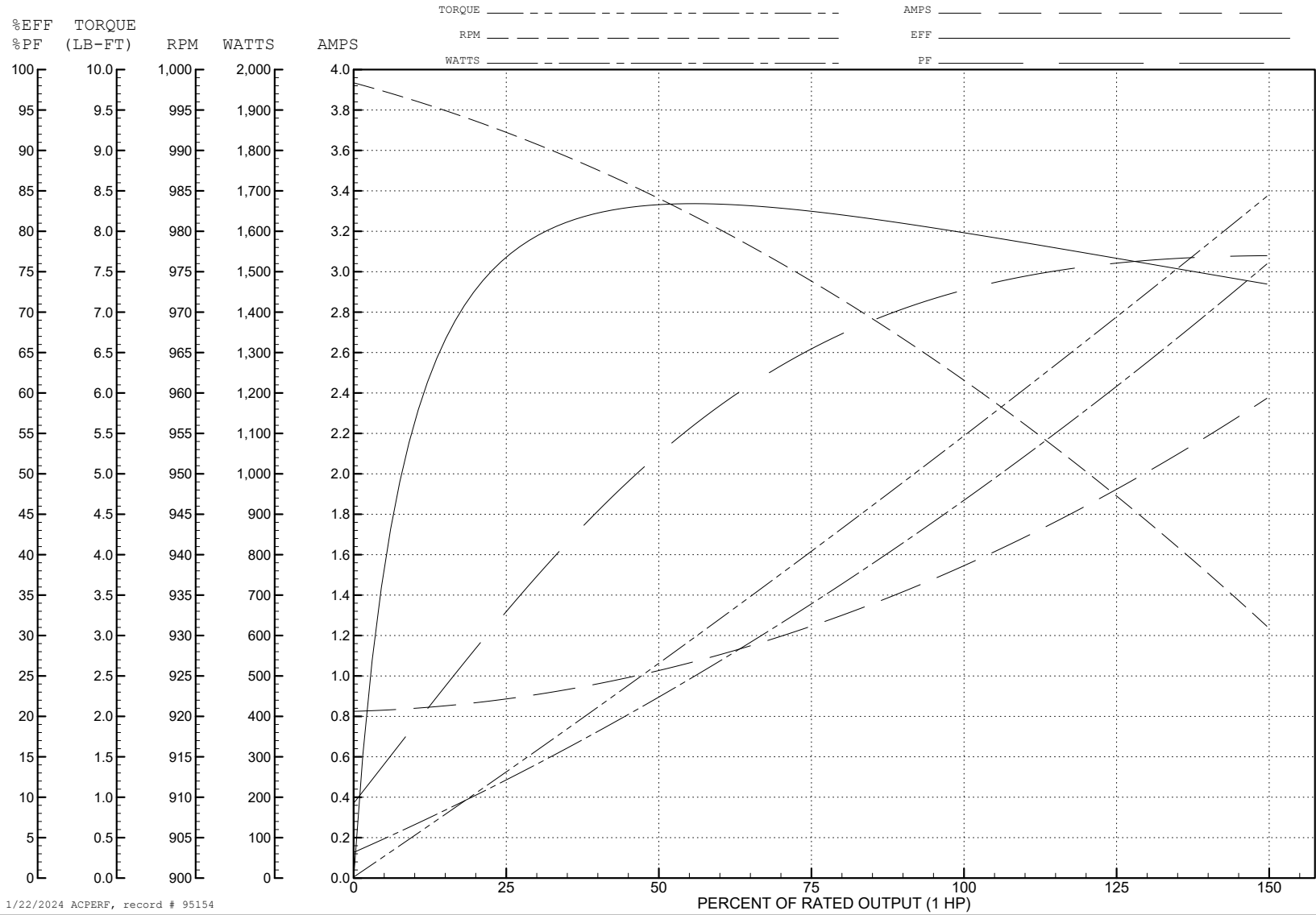

1/22/2024 ACPERF, record # 95154

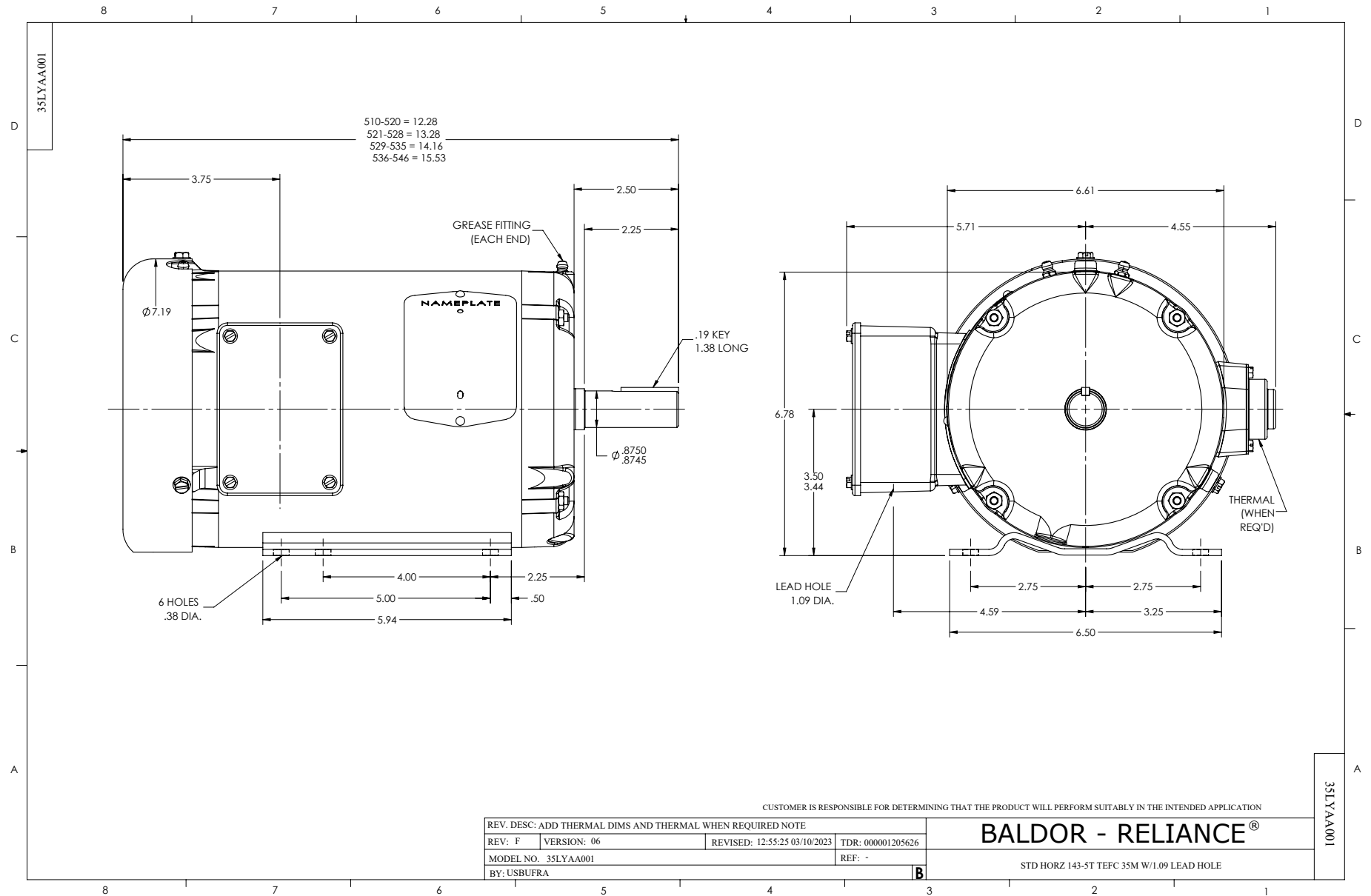

CD0006

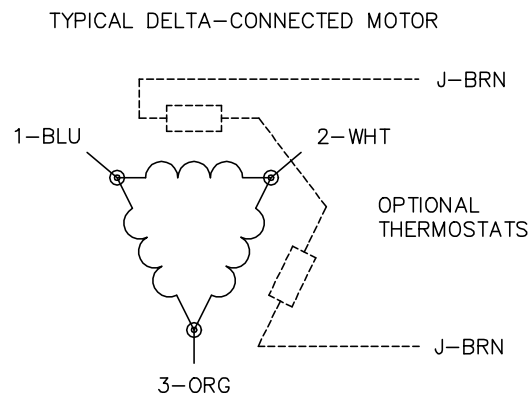
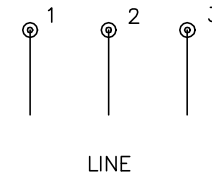
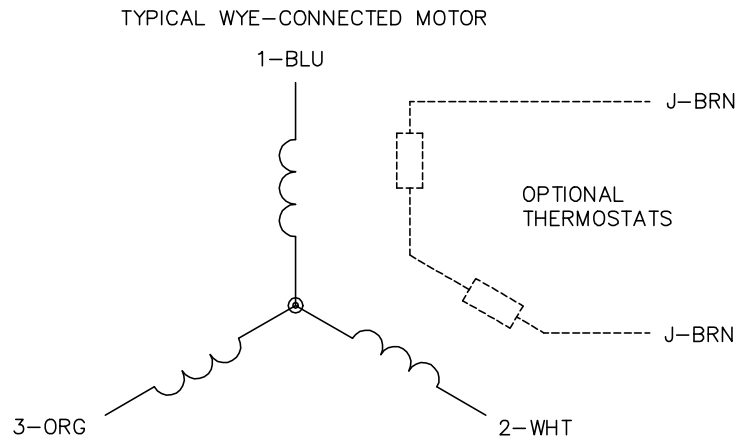

NOTES:

1. THREE LEAD MOTOR MAY BE EITHER WYE CONNECTED OR DELTA CONNECTED.
2. INTERCHANGE ANY TWO LINE LEADS TO REVERSE ROTATION.
3. OPTIONAL THERMOSTATS ARE PROVIDED WHEN SPECIFIED.
4. ACTUAL NUMBER OF INTERNAL PARALLEL CIRCUITS MAY VARY.
5. LEAD COLORS ARE OPTIONAL. LEADS MUST BE NUMBERED AS SHOWN.

CD0006

| | | |
|-----------------------------------|------------------------------|-------------------|
| REV. DESC: ADD CLASS CONN00000007 | | |
| REV. LTR: E | VERSION: 01 | TDR: 000001099922 |
| FILE: \AAA\00005\141 | REVISED: 10:24:49 02/19/2019 | BY: ENBRIRO |
| MTL: - | © □ | |

BALDOR - RELIANCE®

3PH, SV, 3 LEADS, WYE OR DELTA CONNECTED

SH 1 of 1