

**BALDOR® • RELIANCE** 

**Product Information Packet**

**CEM3711T**

**10HP,3490RPM,3PH,60HZ,215TC,3728M,TEFC,F**

Part Detail							
Revision:	P	Status:	PRD/A	Change #:		Proprietary:	No
Type:	AC	Elec. Spec:	37WGS864	CD Diagram:	CD0005	Mfg Plant:	
Mech. Spec:	37G814	Layout:	37LYG814	Poles:	02	Created Date:	11-28-2011
Base:	RG	Eff. Date:	07-03-2019	Leads:	9#14		

Specs			
Catalog Number:	CEM3711T	Heater Indicator:	No Heater
Enclosure:	TEFC	Insulation Class:	F
Frame:	215TC	Inverter Code:	Inverter Duty
Frame Material:	Steel	KVA Code:	G
Motor Letter Type:	Three Phase	Lifting Lugs:	Standard Lifting Lugs
Output @ Frequency:	10.000 HP @ 60 HZ	Locked Bearing Indicator:	Locked Bearing
Synchronous Speed @ Frequency:	3600 RPM @ 60 HZ	Motor Lead Quantity/Wire Size:	9 @ 14 AWG
Voltage @ Frequency:	230.0 V @ 60 HZ	Motor Lead Exit:	Ko Box
	460.0 V @ 60 HZ	Motor Lead Termination:	Flying Leads
XP Class and Group:	None	Motor Type:	3730M
XP Division:	Not Applicable	Mounting Arrangement:	F1
Agency Approvals:	CSA	Power Factor:	88
	CSA EEV	Product Family:	General Purpose
	UR	Pulley End Bearing Type:	Ball
Auxillary Box:	No Auxillary Box	Pulley Face Code:	C-Face
Auxillary Box Lead Termination:	None	Pulley Shaft Indicator:	Standard
Base Indicator:	Rigid	Rodent Screen:	None
Bearing Grease Type:	Polyrex EM (-20F +300F)	RoHS Status:	ROHS COMPLIANT

<b>Blower:</b>	None	<b>Shaft Extension Location:</b>	Pulley End
<b>Current @ Voltage:</b>	24.900 A @ 208.0 V	<b>Shaft Ground Indicator:</b>	No Shaft Grounding
	23.200 A @ 230.0 V	<b>Shaft Rotation:</b>	Reversible
	11.600 A @ 460.0 V	<b>Shaft Slinger Indicator:</b>	No Slinger
<b>Design Code:</b>	B	<b>Speed Code:</b>	Single Speed
<b>Drip Cover:</b>	No Drip Cover	<b>Motor Standards:</b>	NEMA
<b>Duty Rating:</b>	CONT	<b>Starting Method:</b>	Direct on line
<b>Electrically Isolated Bearing:</b>	Not Electrically Isolated	<b>Thermal Device - Bearing:</b>	None
<b>Feedback Device:</b>	NO FEEDBACK	<b>Thermal Device - Winding:</b>	None
<b>Front Face Code:</b>	Standard	<b>Vibration Sensor Indicator:</b>	No Vibration Sensor
<b>Front Shaft Indicator:</b>	None	<b>Winding Thermal 1:</b>	None
		<b>Winding Thermal 2:</b>	None

Nameplate NP3441LUA											
CAT.NO.	CEM3711T										
SPEC	37G814S864G1										
HP	10										
VOLTS	230/460										
AMPS	23.2/11.6										
RPM	3490										
FRAME	215TC					HZ	60		PH	3	
SF	1.15			CODE	G		DES	B		CLASS	F
NEMA NOM. EFF	90.2			PF	88						
RATING	40C AMB-CONT										
CC	010A						USABLE AT 208V		24.9		
ENCL	TEFC			SER							
DE	6307					ODE	6206				
VPWM INVERTER READY											
CT6-60H(10:1)VT3-60H(20:1)	50Hz 10HP 190/380V 28.2/14.1A									SF1.0	

Parts List		
Part Number	Description	Quantity
SA234919	SA 37G814S864G1	1.000 EA
RA221884	RA 37G814S864G1	1.000 EA
36FN3000C02SP	EXFN, PLASTIC, 5.25 OD, 1.175 ID	1.000 EA
HW3200A01	3/8-16X3/4 I-BLT WELDED F/S	1.000 EA
37CB3006	37 CB CASTING W/1.38 LEAD HOLE @ 6:00	1.000 EA
37GS1000SP	GASKET, CONDUIT BOX STD., .06 THICK LEXI	1.000 EA
51XW2520A12	.25-20 X .75, TAPTITE II, HEX WSHR SLTD	2.000 EA
11XW1032G06	10-32 X .38, TAPTITE II, HEX WSHR SLTD U	1.000 EA
37EP3101A01	FR ENDPLATE, FOR ROUTING PURPOSES	1.000 EA
HW4500A01	1641B(ALEMITE)400 UNIV, GREASE FITT	1.000 EA
HW5100A06	W2420-025 WVY WSHR (WB)	1.000 EA
37PE3300A01	PUEP ASSEMBLY FOR ROUTING	1.000 EA
HW4500A01	1641B(ALEMITE)400 UNIV, GREASE FITT	1.000 EA
10XN2520A30	HEX HD CAP SCREW-STD THD-.25 X 20 THD PE	4.000 EA
HW1001A25	LOCKWASHER 1/4, ZINC PLT .493 OD, .255 I	4.000 EA
XY3118A12	5/16-18 HEX NUT DIRECTIONAL SERRATION	4.000 EA
51XB1214A20	12-14X1.25 HXWSSLD SERTYB	1.000 EA
07FH4007SP	PRIMED	1.000 EA
51XW1032A06	10-32 X .38, TAPTITE II, HEX WSHR SLTD S	3.000 EA
37CB4516	LIPPED LID FOR 37 FRAME NEC KOBX	1.000 EA
37GS1008	37 GS FOR CB LID - LEXIDE	1.000 EA
51XW0832A07	8-32 X .44, TAPTITE II, HEX WSHR SLTD SE	4.000 EA
HW2501F21	KEY, 5/16 SQ X 2.375	1.000 EA
HA7000A02	KEY RETAINER RING, 1 1/8 DIA, 1 3/8 DIA	1.000 EA

<b>Parts List (continued)</b>		
<b>Part Number</b>	<b>Description</b>	<b>Quantity</b>
85XU0407S04	4X1/4 U DRIVE PIN STAINLESS	2.000 EA
LB1115N	LABEL,LIFTING DEVICE (ON ROLLS)	1.000 EA
MJ1000A02	GREASE, POLYREX EM EXXON	0.050 LB
MG1000Y03	MUNSELL 2.53Y 6.70/ 4.60, GLOSS 20,	0.028 GA
HA3104A14	THRUBOLT- 5/16-18 X12.125(OHIO)	4.000 EA
LC0005E01	CONN.DIA./WARNING LABEL (LC0005/LB1119N)	1.000 EA
NP3441LUA	ALUM SUPER-E VPWM INV READY UL CSA-EEV C	1.000 EA
G0PA1000	PKG GRP, PRINT PK1026A06	1.000 EA
MN416A01	TAG-INSTAL-MAINT no wire (2200bx) 4/22	1.000 EA

**AC Induction Motor Performance Data**

Record # 53399

Typical performance - not guaranteed values

<b>Winding: 37WGS864-R028</b>		<b>Type: 3730M</b>		<b>Enclosure: TEFC</b>	
<b>Nameplate Data</b>			<b>460 V, 60 Hz: High Voltage Connection</b>		
<b>Rated Output (HP)</b>	10	<b>Full Load Torque</b>	14.94 LB-FT		
<b>Volts</b>	230/460	<b>Start Configuration</b>	direct on line		
<b>Full Load Amps</b>	23.2/11.6	<b>Breakdown Torque</b>	46.1 LB-FT		
<b>R.P.M.</b>	3490	<b>Pull-up Torque</b>	19.3 LB-FT		
<b>Hz</b>	60 <b>Phase</b>	3	<b>Locked-rotor Torque</b>	23.7 LB-FT	
<b>NEMA Design Code</b>	<b>B KVA Code</b>	G	<b>Starting Current</b>	77.3 A	
<b>Service Factor (S.F.)</b>	1.15	<b>No-load Current</b>	3.66 A		
<b>NEMA Nom. Eff.</b>	90.2	<b>Power Factor</b>	88	<b>Line-line Res. @ 25°C</b>	1.05 Ω
<b>Rating - Duty</b>	40C AMB-CONT		<b>Temp. Rise @ Rated Load</b>	78°C	
<b>S.F. Amps</b>			<b>Temp. Rise @ S.F. Load</b>	97°C	
			<b>Locked-rotor Power Factor</b>	33.7	
			<b>Rotor inertia</b>	0.273 LB-FT <sup>2</sup>	

**Load Characteristics 460 V, 60 Hz, 10 HP**

<b>% of Rated Load</b>	<b>25</b>	<b>50</b>	<b>75</b>	<b>100</b>	<b>125</b>	<b>150</b>	<b>S.F.</b>
<b>Power Factor</b>	57	78	85	88	90	89	88
<b>Efficiency</b>	88.6	91.7	91.6	90.6	89.1	87.3	90
<b>Speed</b>	3573	3548	3520	3489	3455	3417	3464
<b>Line amperes</b>	4.56	6.49	8.9	11.6	14.6	17.9	13.5

Performance Graph at 460V, 60Hz, 10.0HP Typical performance - Not guaranteed values

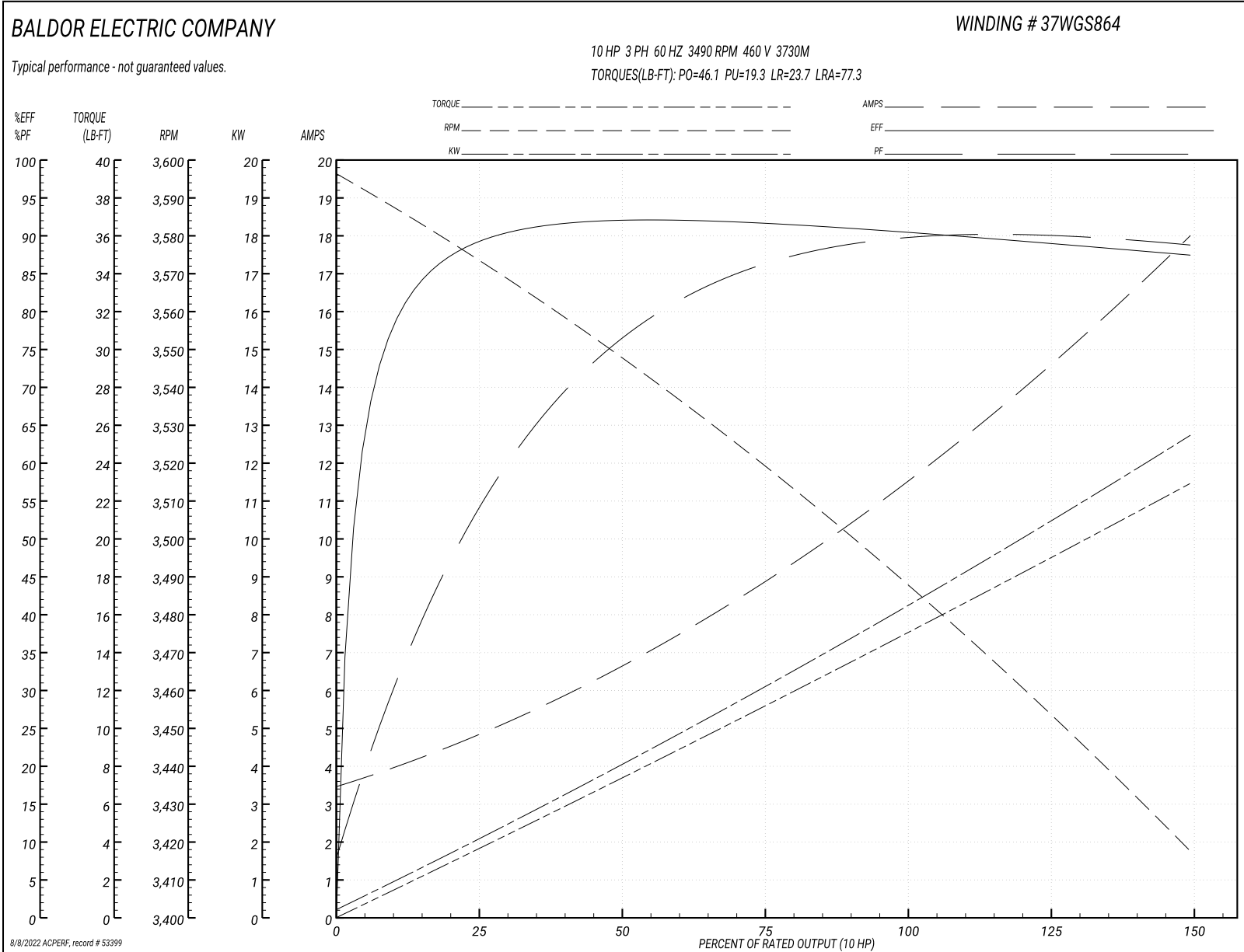



**AC Induction Motor Performance Data**

Record # 59174

Typical performance - not guaranteed values

<b>Winding: 37WGS864-R028</b>		<b>Type: 3728M</b>		<b>Enclosure: TEFC</b>	
<b>Nameplate Data</b>			<b>230 V, 60 Hz: Low Voltage Connection</b>		
<b>Rated Output (HP)</b>	10	<b>Full Load Torque</b>	15 LB-FT		
<b>Volts</b>	230/460	<b>Start Configuration</b>	direct on line		
<b>Full Load Amps</b>	23.6/11.8	<b>Breakdown Torque</b>	45.7 LB-FT		
<b>R.P.M.</b>	3490	<b>Pull-up Torque</b>	21.9 LB-FT		
<b>Hz</b>	60 <b>Phase</b>	3	<b>Locked-rotor Torque</b>	25.4 LB-FT	
<b>NEMA Design Code</b>	<b>B KVA Code</b>	<b>G</b>	<b>Starting Current</b>	152 A	
<b>Service Factor (S.F.)</b>	1.15		<b>No-load Current</b>	8.25 A	
<b>NEMA Nom. Eff.</b>	90.2	<b>Power Factor</b>	87	<b>Line-line Res. @ 25°C</b>	0.248 Ω
<b>Rating - Duty</b>	40C AMB-CONT		<b>Temp. Rise @ Rated Load</b>	79°C	
<b>S.F. Amps</b>			<b>Temp. Rise @ S.F. Load</b>	98°C	
			<b>Locked-rotor Power Factor</b>	33.1	
			<b>Rotor inertia</b>	0.255 LB-FT <sup>2</sup>	

**Load Characteristics 230 V, 60 Hz, 10 HP**

<b>% of Rated Load</b>	<b>25</b>	<b>50</b>	<b>75</b>	<b>100</b>	<b>125</b>	<b>150</b>	<b>S.F.</b>
<b>Power Factor</b>	53	74	84	87	88	89	88
<b>Efficiency</b>	86.7	91	91.4	90.6	89.1	87.3	90
<b>Speed</b>	3575	3547	3516	3482	3445	3401	3464
<b>Line amperes</b>	9.88	13.7	18.2	23.6	29.5	36	27.1

Performance Graph at 230V, 60Hz, 10.0HP Typical performance - Not guaranteed values

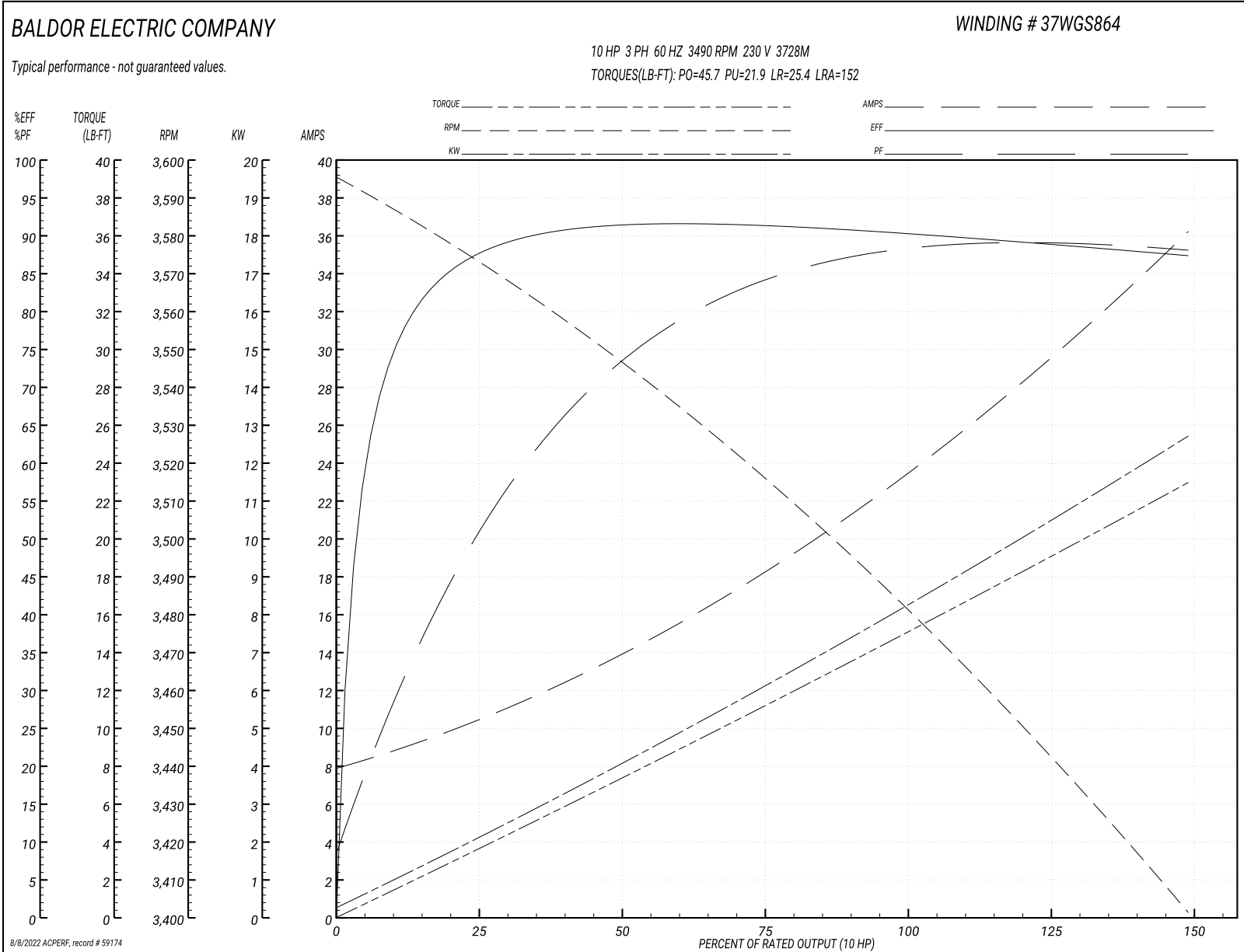

**AC Induction Motor Performance Data**

Record # 69805

Typical performance - not guaranteed values

<b>Winding: 37WGS864-R028</b>		<b>Type: 3728M</b>		<b>Enclosure: TEFC</b>	
<b>Nameplate Data</b>			<b>480 V, 60 Hz: High Voltage Connection</b>		
<b>Rated Output (HP)</b>	10	<b>Full Load Torque</b>	14.97 LB-FT		
<b>Volts</b>	230/460	<b>Start Configuration</b>	direct on line		
<b>Full Load Amps</b>	23.6/11.8	<b>Breakdown Torque</b>	50.07 LB-FT		
<b>R.P.M.</b>	3490	<b>Pull-up Torque</b>	24.32 LB-FT		
<b>Hz</b>	60 <b>Phase</b>	3	<b>Locked-rotor Torque</b>	28.21 LB-FT	
<b>NEMA Design Code</b>	<b>B KVA Code</b>	G	<b>Starting Current</b>	80.47 A	
<b>Service Factor (S.F.)</b>	1.15	<b>No-load Current</b>	4.85 A		
<b>NEMA Nom. Eff.</b>	90.2	<b>Power Factor</b>	87	<b>Line-line Res. @ 25°C</b>	0.991 Ω
<b>Rating - Duty</b>	40C AMB-CONT		<b>Temp. Rise @ Rated Load</b>	78°C	
<b>S.F. Amps</b>			<b>Temp. Rise @ S.F. Load</b>	97°C	
			<b>Locked-rotor Power Factor</b>	33.1	
			<b>Rotor inertia</b>	0.255 LB-FT <sup>2</sup>	

**Load Characteristics 480 V, 60 Hz, 10 HP**

<b>% of Rated Load</b>	<b>25</b>	<b>50</b>	<b>75</b>	<b>100</b>	<b>125</b>	<b>150</b>	<b>S.F.</b>
<b>Power Factor</b>	46	67	78	83	86	87	85
<b>Efficiency</b>	85.9	90.5	91.2	90.5	89.3	87.6	89.8
<b>Speed</b>	3577	3550	3521	3489	3454	3414	3468
<b>Line amperes</b>	5.56	7.29	9.34	11.81	14.5	17.52	13.4

Performance Graph at 480V, 60Hz, 10.0HP Typical performance - Not guaranteed values

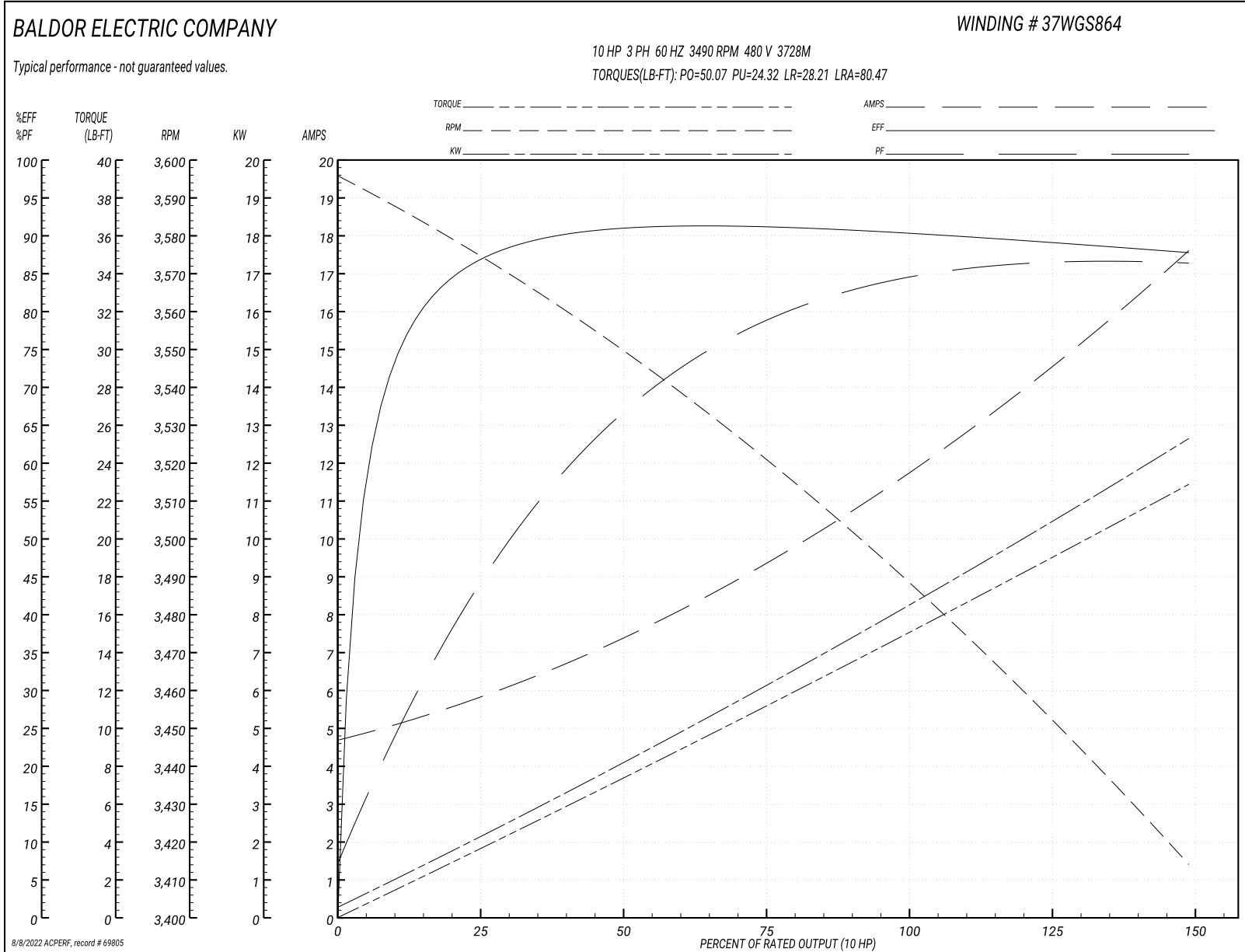

37LYG814

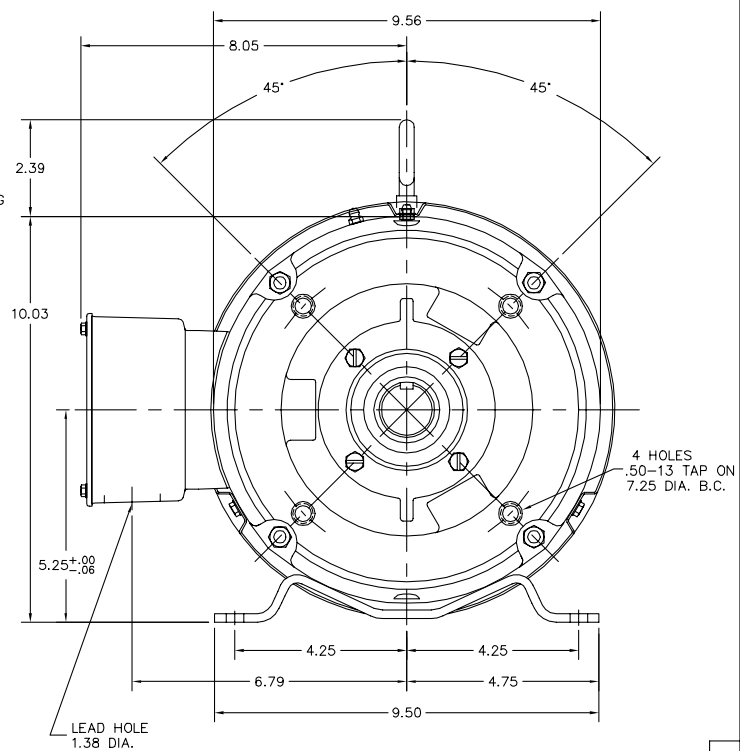
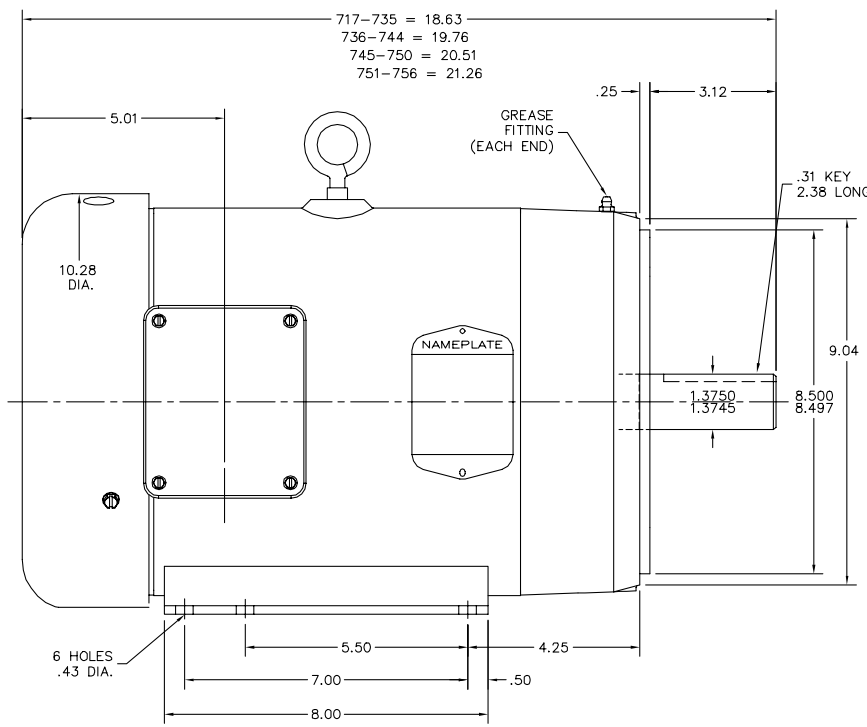

37LYG814

CUSTOMER IS RESPONSIBLE FOR DETERMINING THAT BALDOR'S PRODUCT WILL PERFORM SUITABLY IN THE INTENDED APPLICATION.

REV. DESC: UPDATE LAYOUT GRAPHICS - NO DIM CHANGES		
REV. LTR: D	VERSION: 01	TDR: 000000859468
FILE: \AAA\00051\948	REVISED: 11:08:35 06/24/2014	BY: ENBRAMO
MTL: -		

**BALDOR**

STD HORZ 213-5TC TEFC 37M W/EPACT SHOVE

SH 1 of 1

CD0005



LOW VOLTAGE  
(2Y)

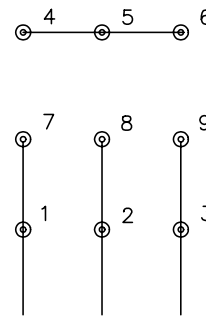

LINE

HIGH VOLTAGE  
(1Y)

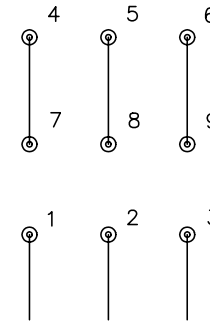

LINE

NOTES:

1. INTERCHANGE ANY TWO LINE LEADS TO REVERSE ROTATION.
2. OPTIONAL THERMOSTATS ARE PROVIDED WHEN SPECIFIED.
3. ACTUAL NUMBER OF INTERNAL PARALLEL CIRCUITS MAY BE A MULTIPLE OF THOSE SHOWN ABOVE.
4. LEAD COLORS ARE OPTIONAL. LEADS MUST ALWAYS BE NUMBERED AS SHOWN.

REV. DESC: REVISE TO SHOW OPTIONAL COLORS

REV. LTR: E BY: JLP

REVISED: 01/19/99 10:15

TDR: 0171435

90000

FILE: AAA00005140

MDL: -

MTL: -

**BALDOR ELECTRIC Co.**

3PH, DV, 9 LEADS

CD0005